

HIDEX



Liquid Scintillation Counters



The new dimension of versatility

Our mission is to help your lab become more effective and make your work a pleasure by providing user-friendly instruments with ultimate performance and versatility.

With the right tools we guarantee you can focus on your work.



Hidex offers the broadest range of liquid scintillation counters available

Hidex offers the broadest range of liquid scintillation counters available.

From portable field deployable single sample counters...

...to high performance super low level systems...

...and high sample capacity automated systems for centralized labs.



Triathler



Hidex 300 SL



Hidex 600 SLe

Hidex has served the liquid scintillation counting community for over twenty years. Our pioneering work started with the world's first portable liquid scintillation counter - the Triathler. Over the years Hidex has introduced ground breaking innovations such as graphical 3D alpha beta separation, luminescence free triple coincidence counting, first combined LSC and gamma counter and the worlds first commercial TDCR triple to double coincidence counter.

Our commitment to advancing scintillation counting is today stronger than ever. That is why we bring new innovation, new products and unrivalled service and support world wide.

Absolute activity counting with TDCR technology

Hidex automatic liquid scintillation counters are equipped with a triple photomultiplier detector. This enables triple to double coincidence ratio TDCR counting, which is an absolute counting method for obtaining counting efficiency of the samples without external or internal standard sources. Unlike external standard methods TDCR is a universal method applicable for both chemical and color quenching, for aqueous and organic samples and for different cocktails and range of isotopes. TDCR method can be used not only for counting of typical beta isotopes like ^3H and ^{14}C but also for absolute activity determination of Cerenkov radiation e.g. from $^{90}\text{Y}/^{90}\text{Sr}$ and monoenergetic isotopes such as ^{55}Fe .

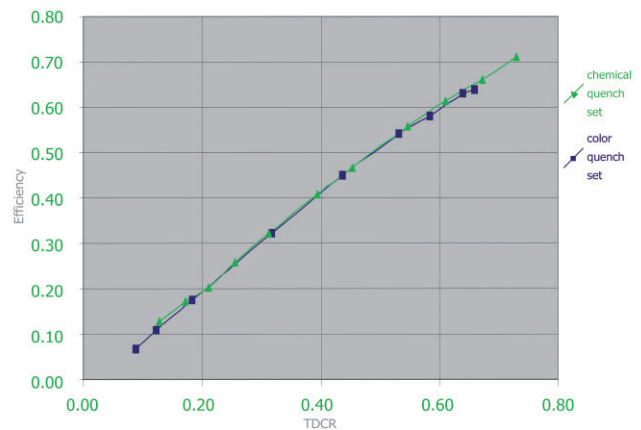

Optimal lead shield design with a minimum of 70 mm shielding in all directions provides good shielding and minimizes instrument weight.

Lead shutter provides optimal shielding from cosmic radiation.

Measurement chamber with high reflective opaque paint maximises light collection.

Three PMTs with highly reflective measurement chamber design provide optimal measurement geometry and facilitate TDCR counting.

Robotic loading arm removes the need for a complex elevator mechanism. Vertical shielding both on top and bottom of detector chambers provides biggest reduction of background effects.

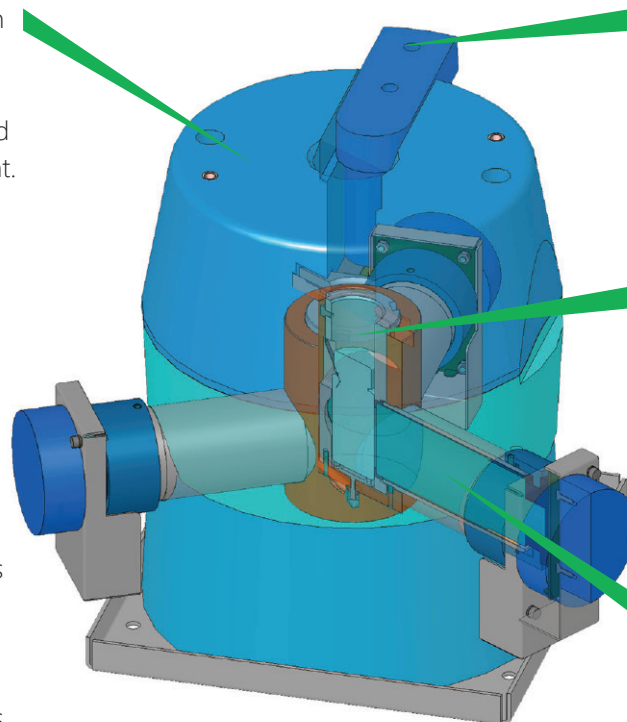

Technical innovations

Luminescence free counting

Hidex 300 SL can be used in triple coincidence mode only, which removes interference from chemiluminescence. Samples with long luminescence decay such as ^{14}C in NaOH can be counted immediately without the need to dark adapt. Method is applicable also for detection of ^3H detection in water.

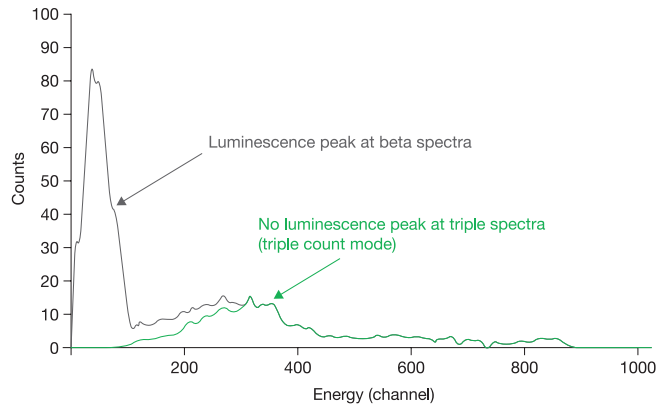

Exceptionally high counting efficiency

The 300 SL utilizes three PMTs aligned at 120° from each other. Optimum detection geometry yields in better detection geometry than conventional double coincidence detector. And the more there is quenching, the greater the advantage of triple coincidence detector

Example: Efficiency for ^3H (in 20 ml vials)

	Hidex 300 SL	Traditional Double Coincidence Counters
Unquenched	> 70 %	65 %
^3H in water	> 35 %	25 %
^3H in water, high quench	10 %	5 %

Alpha/beta separation

Most advanced alpha beta separation is available as an option on the Hidex 300 SL. It facilitates extremely sensitive detection of alpha isotopes in presence of high beta radiation. Calibration and results validation can be done using convenient and reliable 2D/3D spectrum analysis tool without laborious and isotope specific misclassification run. Separation works even for

unknown mixture of alpha and beta isotopes. Typical applications include detection of ^{222}Rn , $^{226/228}\text{Ra}$, ^{241}Am and gross alpha/beta. Calibration and verification of results using the 3D graph tool improves reliability of the results by avoiding uncertainty caused by conventional calibration using different isotopes than the actual samples.

TDCR Cerenkov counting

Conventional External standard quench correction methods cannot be used for quench correction of Cerenkov radiation. TDCR, however, correlates linearly with Cerenkov-efficiency. The method is simple and can be used e.g. for absolute activity determination of $^{90}\text{Y}/^{90}\text{Sr}$, reducing the total detection time even by several days.

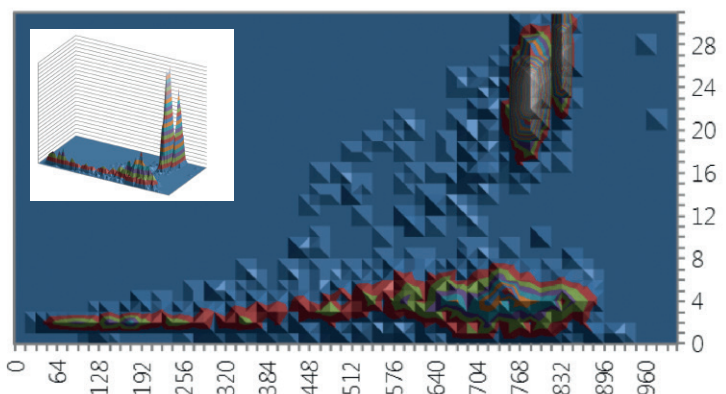



External Standard

External ^{152}Eu standard source can be provided as an optional item. This provides conventional quench correction using external quench parameter. It is recommended for environmental activity samples with variable quenching.

Temperature control unit

Both the Hidex 300 SL and 600 SLe can be equipped with an external cooling unit. This compressor based unit cools the inside of the instrument specifically the detector and the sample waiting areas to a controlled level. Sample temperature stability is especially important in low level applications and improves the reproducibility of results and cocktail sample mixing properties.

User friendly software

The 300 SL is operated using an external PC with Windows 10 compatible MikroWin 300 SL or 600 SLe software, featuring an easy-to-use graphical interface and extensive data reduction capabilities including quench curve analysis and half-life correction. The software is designed for multiuser environment, enabling unlimited number of methods for different isotopes and easy data export to Excel or other programs. Users can add samples with new methods, and high priority samples while the instrument is counting. MikroWin is also 21 CFR Part 11 compliant.

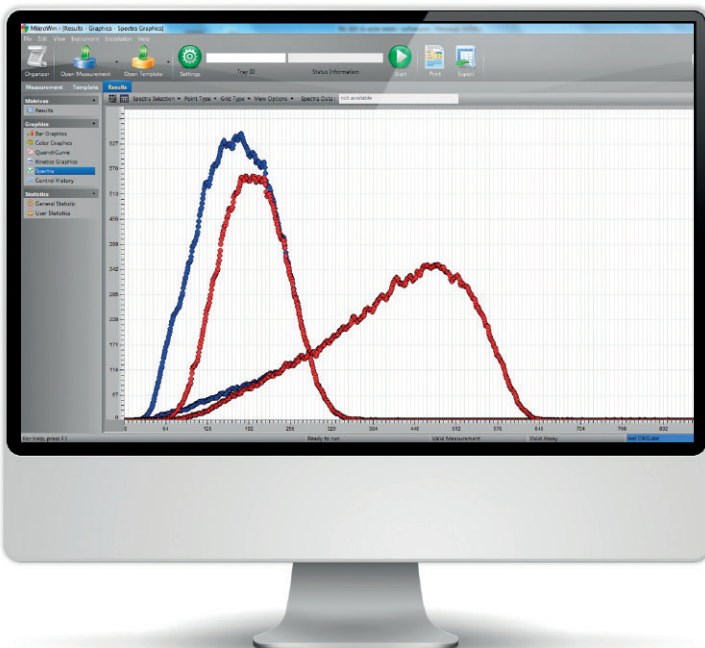

Hidex 300 SL

The most advanced transportable and user friendly LSC on the market

The Hidex 300SL is a revolutionary instrument which incorporates the most advanced triple-PMT detector technology facilitating

- exceptionally high counting efficiency,
- luminescence free counting mode
- absolute activity counting without external radioactive source using triple-to-double coincidence ratio (TDCR) method.

Hidex 300 SL is ideal for all routine scintillation counting applications. For example routine monitoring of beta emitters in nuclear power stations is easy to perform with the Hidex 300 SL. Results can be printed out with required uncertainty calculations providing hassle free operation with no further data analysis needs.

Compact and transportable

The 300 SL has a modern and compact design measuring half the size and weight of some of its long standing rivals. It is therefore much easier to install and fit it into smaller, more space conscious laboratories, such as research vessels or mobile labs.



Ordering information

	Hidex 300 SL #425-201	Hidex 300 SL Super Low Level #425-020	Hidex 300 SL Metrology #425-202
Sample capacity, 20/7/5 mL	40/96/96	40/96/96	40/96/96
Counting efficiency $^3\text{H}/^{14}\text{C}$ (%)	70/96	70/96	70/96
Background ^3H in water (CPM)	12	3	12
Dimensions, W/H/D (cm)	52/68/63	52/68/63	52/68/63
Weight (kg)	125	180	125

Optional features

525-003	alpha/beta separation	462-019	External ^{152}Eu std source
425-2003	Cooling	425-016	Low Level option

Hidex 600 SLe

The most efficient Liquid Scintillation Counter

New enhanced version!



Hidex 600 SLe is new enhanced version of Hidex 600 SL, the most efficient liquid scintillation counter on the market.

Hidex 600 SLe is designed for high sample load capacity required in centralized laboratories.

The Hidex 600 SLe uses the robust and convenient triple to double coincidence ratio TDCR counting well known from the 300 SL series. With the added sample capacity of over 500 small vials or 200 large vials even the most crowded labs can rely on this work horse. Samples are loaded in racks with barcode template identifier which makes multi user environment with different needs extremely easy.

With the high sample capacity and convenient multi user interface the Hidex 600 SLe is ideal for example drug metabolism and pharmacokinetic studies using radioisotopes.

New design with smart improvements

600 SLe has new more stylish and user-friendly design and improved features. New model has for example enhanced cooler where samples are also cooled in the conveyor. The software is more stable in terms of updates and communication. Sample specific QR-code reading is a new option that ensures the consistency between sample and result.

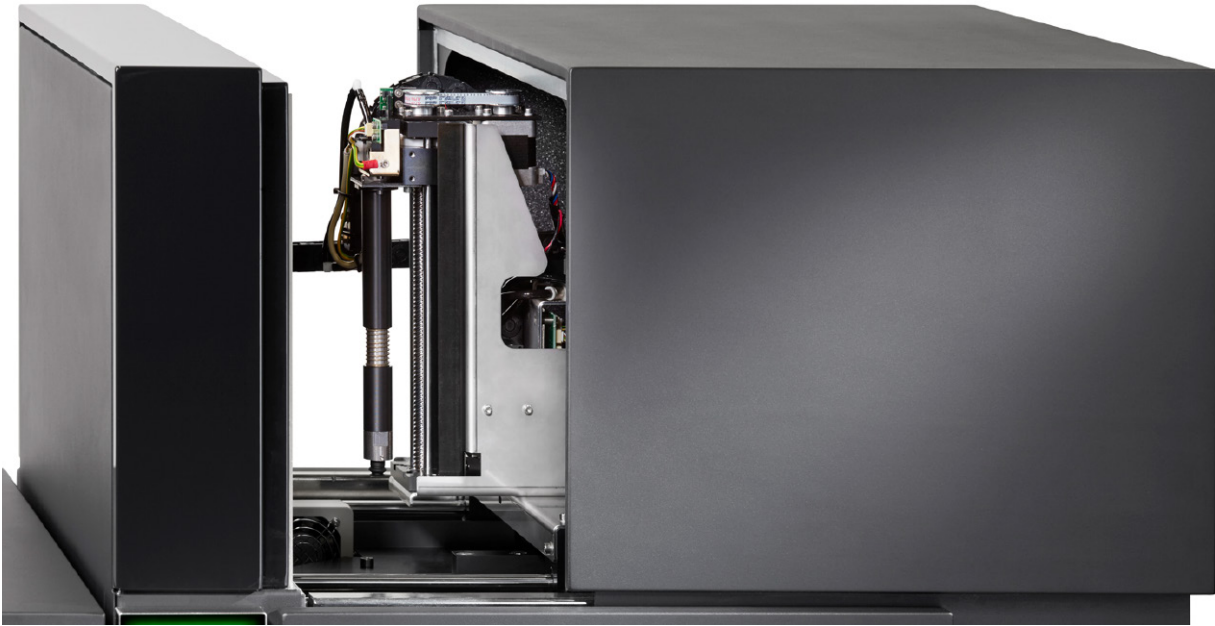

Optional features

The Hidex 600 SLe is available with all the options you get in a standard Hidex counter. Hidex's powerful alpha/beta separation, low level option, cooling unit and external ^{152}Eu standard are all options in the Hidex 600 SLe.

Ordering information

	Hidex 600 SLe #425-209	Hidex 600 SLe Super Low Level #425-009	Hidex 600 SLe Metrology #425-207
Sample capacity, 20/7/5 mL	200/500/500	200/500/500	200/500/500
Counting efficiency $^3\text{H}/^{14}\text{C}$ (%)	70/96	70/96	70/96
Background ^3H in water (CPM)	12	3	12
Dimensions, W/H/D (cm)	125/69/64	125/69/64	125/69/64
Weight (kg)	200	255	200

Optional features

425-019	External standard with Eu-152 source	425-2004	Temperature control for 600 SLe
525-003	Alpha/Beta separation	425-016	Low Level option
525-604	Sample QR code reader for 600 SLe		

Hidex Super Low Level Liquid Scintillation Counter Models

- For Challenging Low Level Applications

Based on the tremendous success of the Hidex 300 SL Automatic TDCR liquid scintillation counter Hidex has developed instruments for challenging low radioactivity applications. The Hidex 300 SL and 600 SLe super low-level scintillation counters are equipped with additional lead shielding, low level PMT detectors, and active guard detectors for further background reduction. Hidex Super Low Level instruments are ideal for ^3H in water measurements as well as other low-level environmental monitoring, radiocarbon dating and biofuel verification applications.



Active Guard

The Active Guard is a separate scintillator detector which detects and subtracts real-time background radiation. The guard can be turned off for high energy samples and does not interfere with alpha/beta separation.

Digital Pb shield

Is a proprietary Hidex spectral fitting algorithm that decreases the background and improves the uncertainty of the results by utilizing spectrum information for active sample tritium counts and background counts.

Applications

Low level environmental measurements:

- ^3H & ^{14}C in natural waters
- ground water dating (^3H)
- $^{90}\text{Y}/^{90}\text{Sr}$ (TDCR - Cerenkov quench correction method can be applied)
- gross alpha/beta
- biobased ^{14}C
- low level alphas
- ^{55}Fe , ^{63}Ni
- ^3H & ^{90}Sr radiobioassays

Performance Specifications

All the measurements are performed at temperature of $22^\circ\text{C} \pm 2^\circ\text{C}$ and at normal humidity conditions of Hidex laboratory, Turku, Finland (relative humidity not measured). Background may vary locally depending on natural environmental radiation. Temperature control module is recommended for the most challenging low activity level applications.

Counting efficiency

- Counting efficiency typical > 70 % for ^3H and typical > 96 % for ^{14}C with unquenched samples.
- > 35 % for ^3H quenched (8 mL water sample + 12 mL AquaLight cocktail)
- α 's (^{210}Po , $^{234}\text{U}/^{238}\text{U}$, ^{241}Am , ^{222}Rn , ^{226}Ra) > 95 %

Typical background

- < 3.5 CPM with 8 mL water + 12 mL AquaLight Low Level cocktail.
- *Background value measured using window with 25 % counting efficiency.
- < 0.3 CPM for alphas (with a/b separation option)

FOM (E2/B)

- ^3H in water, optimized window > 220
- ^3H in water, with Digital Pb shield > 300
- ^3H unquenched Low Level standards, optimized window > 350
- ^{14}C unquenched Low Level standards, optimized window > 1150
- ^{14}C Benzene 3.5 ml in a mini glass vial > 2000 (71 % window / 2.5 CPM background)

Triathler – The Versatile Counter

Triathler has been thoroughly tested and proven under extreme conditions. Nearly 2000 units have been delivered and they are used in all kinds of laboratories and in some of the planet's most demanding environments – in the desert and jungle, as well as on ocean-going vessels and oil platforms.

Ideal for:

- Homeland Security
- Radiation Safety
- Wipe Tests
- Life Sciences
- Molecular Biology
- Ecology
- Environmental Testing

Features

Triathler is a single-sample counter, which provides fast and accurate results for several life science and environmental applications. It can count all radioisotopes including tritium in a variety of sample formats. Due to its very small size and light weight, Triathler can be taken into the field to measure samples on the spot. Although compact, Triathler has many advanced features such as advanced spectrum analysis using a multichannel analyzer (MCA), Instant DPM results, single-photon luminescence counting, and optional alpha beta separation.



Ordering information

Code No Triathler

425-014	Triathler Luminometer
425-024	Triathler Gamma Counter
425-034	Triathler LSC
425-004	Triathler Multilabel Tester
425-010	Triathler NaI System
425-011	Triathler Becquerel Finder

Optional items

525-001	Alpha/beta separation
525-110	Internal lead shield for LSC with low-level PMT
525-100	Internal lead shield for MLT with low-level PMT
431-040	External NaI detector with enlarged crystal and lead shielding
431-043	External Bq Detector with enlarged crystal and lead shielding, for Marinelli beakers
431-302	Field case
525-203	Field case with battery
431-303	Field case with wheels
525-204	Field case with wheels and battery

Additional services and products

Validation

Hidex offers instrument installation and training with full validation services for GMP laboratories. IQ and OQ methods and scripts are available as additional service for the validated laboratories.

Service contracts

To ensure optimal performance and guarantee zero down time Hidex offers service contracts after warranty period.

Standards

Hidex offers a range of standards for instrument calibration and validation. Unquenched and quenched standards are NIST traceable. Internal standards are also available for validating cocktails, vials and sample preparation procedures.

Cocktails

Broad range of aqueous and non aqueous cocktails with extremely high performance and optimised alpha beta separation characteristics.

Vials

A large variety of different vials are available together with your instrument. From low volume plastic vials to high performance frosted glass vials – get the best out of your instrument with the right consumables.

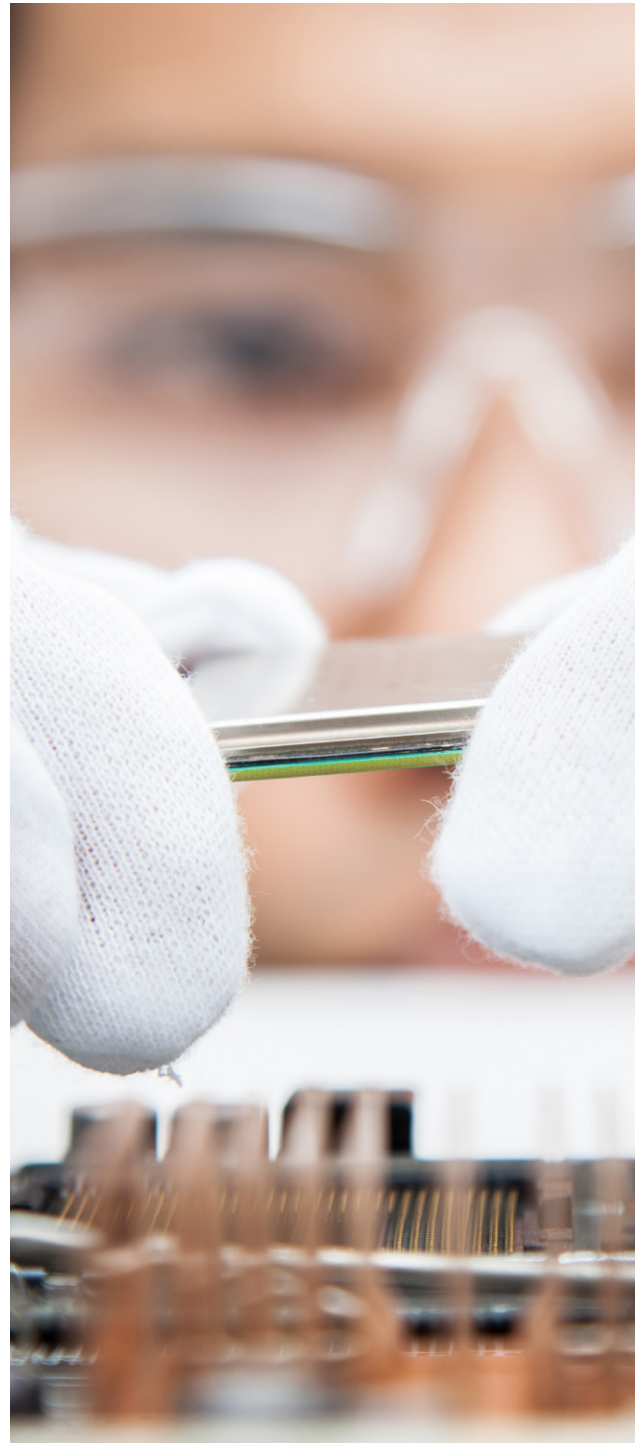

HIDEX

First we focus
on your benefit,
then we create
a product, and
then we do it again.

On point. Repeat.

On point. Repeat.

At Hidex scientific development is at the core of our values. We believe in the scientific advancement and continued improvement of our products. Our passion is to develop and optimise instrument sensitivity, streamline measuring operation and make usability as smooth as possible.

To ensure the continued operation with our instruments we commit to unrivalled support. Our customers can unleash the full potential of our instruments with the support of our application specialists and field support engineers.

Hidex
guarantees you
the state-of-
the-art tools
so you can
focus on your
research.

Because if it's not on point,
what's the point?



Sample preparation for LSC

Hidex sample oxidizer and automatic radiochemistry extraction systems provide users with superior sample preparation capabilities and streamlined workflow to minimize hands-on time.



Hidex Sense

The Hidex Sense microplate reader is loaded with several unique innovative features to provide full flexibility at top performance. With touchscreen operated software and the compact application ready microplate reader, we turn your applications into results, simply at your fingertip.



Hidex Automatic Gamma Counter

The compact design and superior user experience of our touch screen software makes the Hidex Automatic Gamma Counter ideal for nuclear medicine applications.

Family by science.

Hidex is a family owned high technology company which develops and manufactures high performance analysis equipment for life science research, radiation measurement and nuclear medicine. Our products utilize modern technology and excellent tradition of workmanship. With strong links to the scientific community we continue to innovate and develop to improve the research of medicine, safety of nuclear industry, sustainability of the environment and purity of our food and water supplies.

Helping scientific research and safety of everyday life:

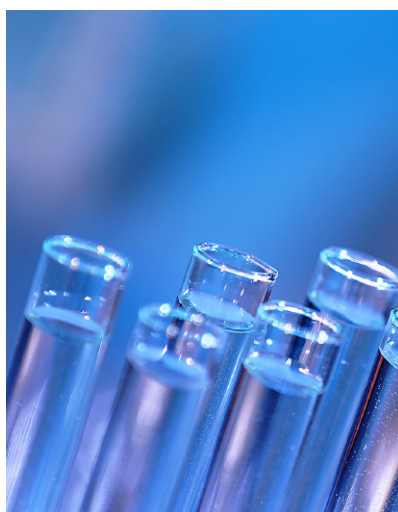

Medical research

- Universities
- Pharmaceutical industry
- CROs
- Biotech startups



Radiation measurement

- Nuclear industry
- Homeland security
- Geology
- Research

Today more than 4000 Hidex precision instruments are at service in leading laboratories worldwide as well as in some of the hardest conditions on the planet. Jungles and deserts, oil platforms and ocean going vessels – even submarines are no challenge for Hidex instruments.

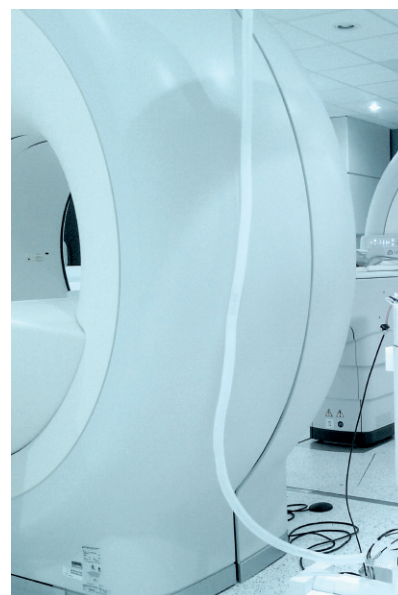

Nuclear medicine and PET

- Nuclear medicine
- Positron emission Tomography

HIDEX

On point. Repeat.

Contact Hidex

Call us

Tel. +358 10 843 5570

Address

Lemminkäisenkatu 62
FIN-20520 Turku
Finland

E-mail

info@hidex.com
firstname.lastname@hidex.com

www.hidex.com