

Industrial Radiation Sources

Product Information



 Eckert & Ziegler
Isotope Products

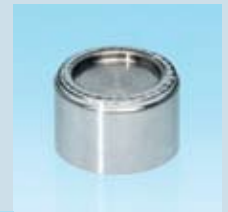

Table of Contents

Industrial Radiation Sources

Product Finder	2
Am-241 Sources	4
Am-241 / Be Sources	8
Ba-133 Sources	12
Cd-109 Sources	16
Cf-252 Sources	18
Co-57 Sources	20
Co-60 Sources	24
Cs-137 Sources	30
Eu-152 Sources	38
Fe-55 Sources	42
Gd-153 Sources	44
Kr-85 Sources	46
Mössbauer Sources	50
Na-22 Sources	52
Ni-63 Sources	53
Pm-147 Sources	54
Ru-106 Sources	55
Se-75 Sources	56
Sr-90 Sources	57
Yb-169 Sources	58
Custom Services	61
QA Information	62
General Information	64
Packaging Information	66
Technical Information	68
Inquiry Form	76

Product Finder

Available Radionuclide/Capsule Combinations

The chart below indicates availability of standard capsule/radionuclide combinations. Capsules are selected from the top row, and nuclides are selected from the left column. A solid block of color in the cell where the capsule column and radionuclide row intersect indicates availability. Unless otherwise stated, capsules are made from 316L stainless steel. Further capsule information can be found in the Technical Information section, pages 68-74.

		Capsules																															
		3000	3011	3014	3015	3023	3024	3025	3026	3036	3044	3201	3202	3203	3204	3205	3215	3222	3224	3233	3236	3402	3603	3616	3807	3882	3888	3902	3916	3918	4500		
Radionuclides	Am-241				■							■			■		■		■	■													
	Am-241/ Be																																
	Ba-133	■	■		■		■													■			■							■	■		
	Cd-109															■	■	■					■										
	Cf-252			■		■	■			■	■																						
	Co-57	■											■	■			■	■					■				■						
	Co-60	■	■		■			■	■			■											■										
	Cs-137	■				■							■								■		■					■		■			
	Eu-152	■	■		■								■										■										
	Fe-55															■		■					■										
	Gd-153												■											■									
	Kr-85																																
	Na-22	■						■																									
	Ni-63																																■
	Pm-147																												■				
	Ru-106																			■													
	Se-75																									■							
	Sr-90														■																		
	Yb-169																								■								

Note 1: the 3402 capsule is stainless steel, and the equivalent 3414 capsule is titanium.

For combinations of radionuclide and capsule you require not shown below, please fill out the Source Design Request Form at the back of this catalog to describe your requirements, and forward to the fax number or email address shown. A Source Design Specialist will contact you.

Capsules

Capsule	Am-241	Am-241/Be	Ba-133	Cd-109	Cf-252	Co-57	Co-60	Cs-137	Eu-152	Fe-55	Gd-153	Kr-85	Na-22	Ni-63	Pm-147	Ru-106	Se-75	Sr-90	Yb-169
NER180																			
NER170																			
NER588																			
NER587																			
NER586																			
NER585																			
NER584																			
P081																			
P08																			
P20																			
P17-1																			
P17																			
P13																			
P08																			
P05																			
P04																			
P03																			
P02																			
N20																			
N09-1																			
N09																			
N03																			
N02																			
G55																			
G44																			
G33																			
G22																			
G11																			
G10																			

Radionuclides

Note 2: capsules 3000, 3015, 3024, 3026, N.03 and N.09-1 have all been tested to at least 25,000 psi and therefore may be used for down-hole O.W.L. applications.

Am-241

Standard Capsule Designs

Activity Tolerance

± 15% from nominal

Recommended Working Life

See Technical Information section.

Only typical sources are listed; inquiries are invited for alternative capsule designs and activities.

For Low Energy Gamma applications, these sources offer a long half-life radionuclide with gamma emissions predominantly below 60keV, incorporating a stable, homogeneous active element. The lower energies are enhanced when beryllium window capsules are used.



3015 capsule

Double-encapsulated stainless steel source. ISO rating: C66535

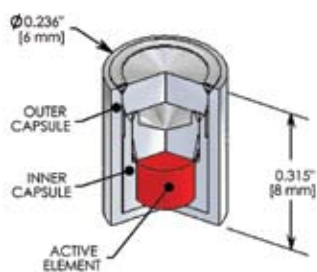

Nominal Activity		Part Numbers	Regulatory
mCi	MBq	3015	SS&DR / SFC
0.1	3.7	AM130150100U	Yes / Yes
0.5	18.5	AM130150500U	Yes / Yes
1	37	AM130150001M	Yes / Yes
5	185	AM130150005M	Yes / Yes
10	370	AM130150010M	Yes / Yes
25	925	AM130150025M	Yes / Yes
50	1850	AM130150050M	Yes / Yes

Availability: 4-8 weeks

3201 capsule

Single-encapsulated stainless steel source. ISO rating: C66545

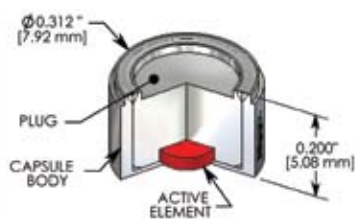

Nominal Activity		Part Numbers	Regulatory
mCi	MBq	3201	SS&DR / SFC
0.1	3.7	AM132010100U	Yes / Yes
0.5	18.5	AM132010500U	Yes / Yes
1	37	AM132010001M	Yes / Yes
5	185	AM132010005M	Yes / Yes
10	370	AM132010010M	Yes / Yes
25	925	AM132010025M	Yes / Yes
50	1850	AM132010050M	Yes / Yes

Availability: 4-8 weeks

3204 capsule

Single-encapsulated stainless steel source with 0.01"/0.25mm beryllium window. ISO rating: C43333



Nominal Activity		Part Numbers	Regulatory
mCi	MBq		
		3204	SS&DR / SFC
0.1	3.7	AM132040100U	Yes / Yes
0.5	18.5	AM132040500U	Yes / Yes
1	37	AM132040001M	Yes / Yes
5	185	AM132040005M	Yes / Yes
10	370	AM132040010M	Yes / Yes
25	925	AM132040025M	Yes / Yes
50	1850	AM132040050M	Yes / Yes
			Availability: 4-8 weeks

3215 capsule

Single-encapsulated stainless steel source with 0.01"/0.25mm beryllium window. ISO rating: C33222

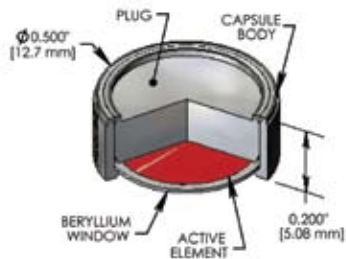

Nominal Activity		Part Numbers	Regulatory
mCi	MBq		
		3215	SS&DR / SFC
0.1	3.7	AM132150100U	Yes / No
0.5	18.5	AM132150500U	Yes / No
1	37	AM132150001M	Yes / No
5	185	AM132150005M	Yes / No
10	370	AM132150010M	Yes / No
25	925	AM132150025M	Yes / No
50	1850	AM132150050M	Yes / No
			Availability: 4-8 weeks

3215 capsules with activities of 27mCi / 1GBq or higher must be shipped using a Type B container.

3224 capsule

Single-encapsulated stainless steel source; stable, homogeneous active element. ISO rating: C66444

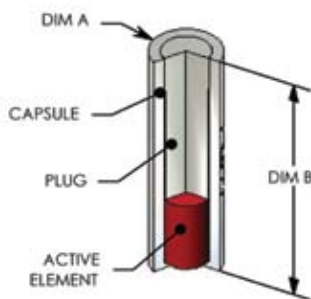

Nominal Activity		Part Numbers	Regulatory
mCi	MBq		
		3224	SS&DR / SFC
0.1	3.7	AM132240100U	Yes / Yes
0.5	18.5	AM132240500U	Yes / Yes
1	37	AM132240001M	Yes / Yes
5	185	AM132240005M	Yes / Yes
10	370	AM132240010M	Yes / Yes
25	925	AM132240025M	Yes / Yes
50	1850	AM132240050M	Yes / Yes
			Availability: 4-8 weeks

See table on p.71 for available 3224 capsule dimensions.

Am-241
Am-241/Be
Ba-133
Cd-109
Cf-252
Co-57
Co-60
Cs-137
Eu-152
Fe-55
Gd-153
Kr-85
Mossbauer
Na-22
Ni-63
Pm-147
Ra-106
Sc-75
Sr-90
Yb-169

Am-241

Standard Capsule Designs

3233 capsule

Single-encapsulated stainless steel source with 0.04"/1.0mm beryllium window. ISO rating: C64344

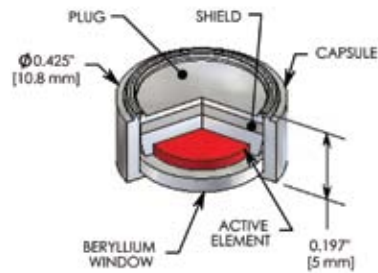

Nominal Activity		Part Numbers	Regulatory
mCi	MBq		
		3233	SS&DR / SFC
0.1	3.7	AM132330100U	Yes / No
0.5	18.5	AM132330500U	Yes / No
1	37	AM132330001M	Yes / No
5	185	AM132330005M	Yes / No
10	370	AM132330010M	Yes / No
30	1010	AM132330030M	Yes / No
50	1850	AM132330050M	Yes / No
100	3700	AM132330100M	Yes / No

Availability: 4-8 weeks

G10 capsule

Single-encapsulated stainless steel source. ISO rating: C66545

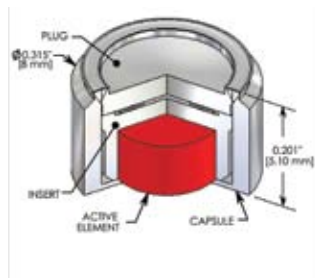

Nominal Activity		Part Numbers	Regulatory
mCi	MBq		
		G10	v
1	37	AM1G100001M	Yes / Yes
2	74	AM1G100002M	Yes / Yes
5	185	AM1G100005M	Yes / Yes
10	370	AM1G100010M	Yes / Yes
15	555	AM1G100015M	Yes / Yes
20	740	AM1G100020M	Yes / Yes
30	1010	AM1G100030M	Yes / Yes

Availability: 7-8 weeks

G11 capsule

Single-encapsulated stainless steel source. ISO rating: C64546

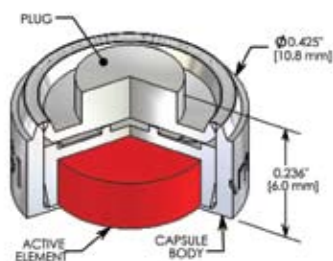

Nominal Activity		Part Numbers	Regulatory
mCi	MBq		
		G11	SS&DR / SFC
0.5	18.5	AM1G110500U	Yes / Yes
1	37	AM1G110001M	Yes / Yes
5	185	AM1G110005M	Yes / Yes
10	370	AM1G110010M	Yes / Yes
20	740	AM1G110020M	Yes / Yes
50	1850	AM1G110050M	Yes / Yes
100	3700	AM1G110100M	Yes / Yes

Availability: 7-8 weeks

Optional G11B capsule also available with beryllium window.

G22 capsule

Single-encapsulated stainless steel source. ISO rating: C64546

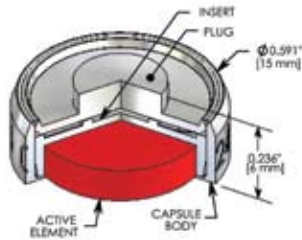

Nominal Activity		Part Numbers	Regulatory
mCi	MBq		
		G22	SS&DR / SFC
50	1850	AM1G220050M	Yes / Yes
100	3700	AM1G220100M	Yes / Yes
200	7400	AM1G220200M	Yes / Yes
300	11100	AM1G220300M	Yes / Yes
			Availability: 7-8 weeks

G33 capsule

Single-encapsulated stainless steel source. ISO rating: C64546

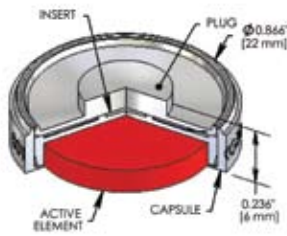

Nominal Activity		Part Numbers	Regulatory
mCi	MBq		
		G33	SS&DR / SFC
100	3700	AM1G330100M	Yes / Yes
200	7400	AM1G330200M	Yes / Yes
300	11100	AM1G330300M	Yes / Yes
500	18500	AM1G330500M	Yes / Yes
			Availability: 7-8 weeks

G44 capsule

Single-encapsulated stainless steel source. ISO rating: C64444

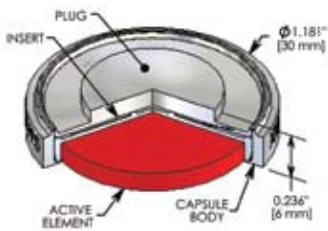

Nominal Activity		Part Numbers	Regulatory
mCi	MBq		
		G44	SS&DR / SFC
250	9250	AM1G440250M	Yes / Yes
500	18500	AM1G440500M	Yes / Yes
750	27750	AM1G440750M	Yes / Yes
1000	37000	AM1G441000M	Yes / Yes
			Availability: 7-8 weeks

G55 capsule

Single-encapsulated stainless steel source. ISO rating: E64444

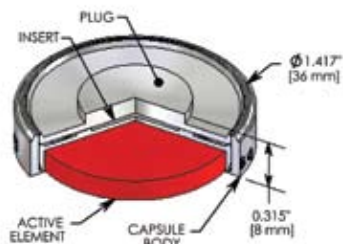

Nominal Activity		Part Numbers	Regulatory
mCi	GBq		
		G55	SS&DR / SFC
1000	37	AM1G551000M	Yes / Yes
2000	74	AM1G552000M	Yes / Yes
3000	111	AM1G553000M	Yes / Yes
			Availability: 7-8 weeks

Am-241
Am-241/Be
Ba-133
Cd-109
Cs-252
Co-57
Co-60
Cs-137
Eu-152
Fe-55
Gd-153
K-85
Mössbauer
Na-22
Ni-63
Pm-147
Ru-106
Se-75
Sr-90
Yb-169

Am-241

Standard Capsule Designs

P08 capsule

Singe-encapsulated stainless steel source; stable, homogeneous active element. ISO rating: C64444

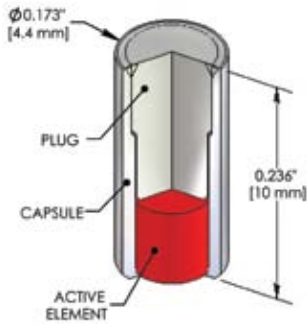

Nominal Activity		Part Numbers	Regulatory
mCi	MBq		
		P08	SS&DR / SFC
1	37	AM1P080001M	Yes / No
25	925	AM1P080025M	Yes / No
50	1850	AM1P080050M	Yes / No
100	3700	AM1P080100M	Yes / No
200	7400	AM1P080200M	Yes / No
			Availability: 8-10 weeks

P081 capsule

Singe-encapsulated stainless steel source; stable, homogeneous active element. ISO rating: C64444

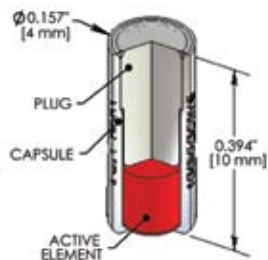

Nominal Activity		Part Numbers	Regulatory
mCi	MBq		
		P081	SS&DR / SFC
1	37	AM1P0810001M	Yes / No
25	925	AM1P0810025M	Yes / No
50	1850	AM1P0810050M	Yes / No
100	3700	AM1P0810100M	Yes / No
150	5550	AM1P0810150M	Yes / No
			Availability: 8-10 weeks



Am-241	Am-241/Be	Ba-133	Cd-109	Cf-252	Co-57	Co-60	Cs-137	Eu-152	Fe-55	Gd-153	Kr-85	Mössbauer	Na-22	Ni-63	Pm-147	Ru-106	Se-75	Sr-90	Yb-169
--------	-----------	--------	--------	--------	-------	-------	--------	--------	-------	--------	-------	-----------	-------	-------	--------	--------	-------	-------	--------

Am-241 / Be

Standard Capsule Designs

Activity Tolerance

± 15% from nominal

Recommended Working Life

See Technical Information section.

Only typical sources are listed; inquiries are invited for alternative capsule designs and activities.

Am-241/Be neutron sources for geological prospecting, moisture gauging, activation analysis, nuclear research, and for applications in oil well logging, contain a homogenous mixture of Am-241 and beryllium metal powder.



N02 capsule

Double-encapsulated stainless steel source; stable, homogeneous active element. ISO rating: C66545

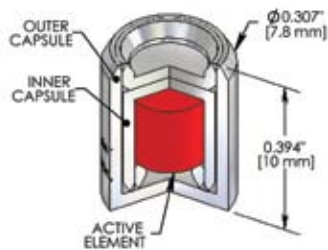

Nominal Activity		Part Numbers	Regulatory
mCi	MBq	N02	SS&DR / SFC
1	37	AM1N020001M	Yes / Yes
10	370	AM1N020010M	Yes / Yes
40	1480	AM1N020040M	Yes / Yes
100	3700	AM1N020100M	Yes / Yes
			Availability: 8-10 weeks

N03 capsule

Double-encapsulated stainless steel source; for oil well logging applications. ISO rating: C66646

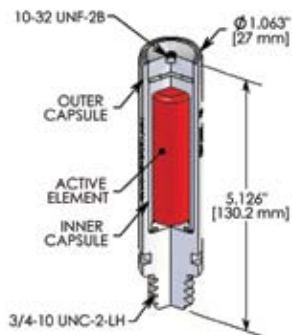

Nominal Activity		Part Numbers	Regulatory
mCi	GBq	N03	SS&DR / SFC
1000	37	AM1N030001C	Yes / Yes
3000	111	AM1N030003C	Yes / Yes
8000	296	AM1N030008C	Yes / Yes
16000	592	AM1N030016C	Yes / Yes
18000	666	AM1N030018C	Yes / Yes
			Availability: 10-12 weeks

Intermediate activities also available; please inquire.

N09 capsule

Double-encapsulated stainless steel source; stable, homogeneous active element. ISO rating: C66544

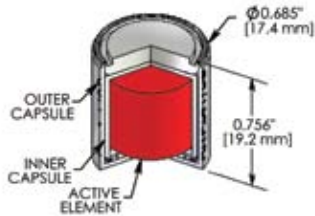

Nominal Activity		Part Numbers	Regulatory
mCi	MBq	N09	SS&DR / SFC
1	37	AM1N090001M	Yes / Yes
10	370	AM1N090010M	Yes / Yes
100	3700	AM1N090100M	Yes / Yes
350	12950	AM1N090350M	Yes / Yes
Availability: 8-10 weeks			

N09-1 capsule

Double-encapsulated stainless steel source; stable, homogeneous active element. ISO rating: C66544

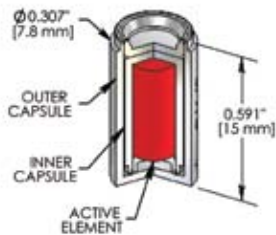

Nominal Activity		Part Numbers	Regulatory
mCi	MBq	N09-1	SS&DR / SFC
2	74	AM1N09-10002M	Yes / Yes
5	185	AM1N09-10005M	Yes / Yes
10	370	AM1N09-10010M	Yes / Yes
100	3700	AM1N09-10100M	Yes / Yes
200	7400	AM1N09-10200M	Yes / Yes
Availability: 8-10 weeks			

N20 capsule

Double-encapsulated stainless steel source; stable, homogeneous active element. ISO rating C66646

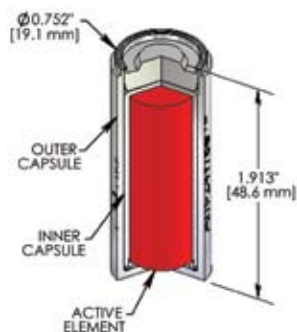

Nominal Activity		Part Numbers	Regulatory
mCi	GBq	N20	SS&DR / SFC
500	18.5	AM1N200500M	No / No
1000	37	AM1N200001C	No / No
2000	74	AM1N200002C	No / No
3000	111	AM1N200003C	No / No
Availability: 8-10 weeks			

Am-241
Am-241/Be
Ba-133
Cd-109
Cs-137
Eu-152
Fe-55
Gd-153
K-85
Mossbauer
Na-22
Ni-63
Pm-147
Ra-106
Sc-75
Sr-90
Yb-169

Ba-133

Standard Capsule Designs

Activity Tolerance

± 15% from nominal

Recommended Working Life

See Technical Information section.

Only typical sources are listed; inquiries are invited for alternative capsule designs and activities.

For High Energy Gamma applications, these sources offer a long half-life radionuclide with gamma emissions up to 384keV and contain a stable, homogeneous active element.



3000 capsule

Double-encapsulated stainless steel source. ISO rating: C66535

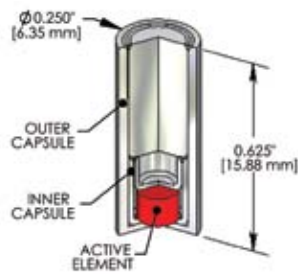

Nominal Activity		Part Numbers	Regulatory
mCi	MBq		
		3000	SS&DR / SFC
0.1	3.7	BA330000100U	Yes / Yes
1	37	BA330000001M	Yes / Yes
5	185	BA330000005M	Yes / Yes
10	370	BA330000010M	Yes / Yes
			Availability: 4 weeks

3011 capsule

Double-encapsulated stainless steel source. ISO rating: C66545

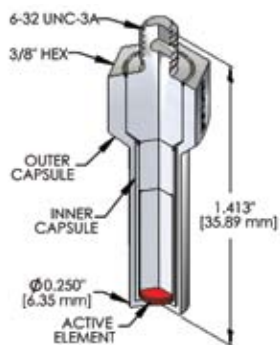

Nominal Activity		Part Numbers	Regulatory
mCi	MBq		
		3011	SS&DR / SFC
0.1	3.7	BA330110100U	Yes / Yes
1	37	BA330110001M	Yes / Yes
5	185	BA330110005M	Yes / Yes
10	370	BA330110010M	Yes / Yes
			Availability: 4 weeks

3015 capsule

Double-encapsulated stainless steel source. ISO rating: C66535

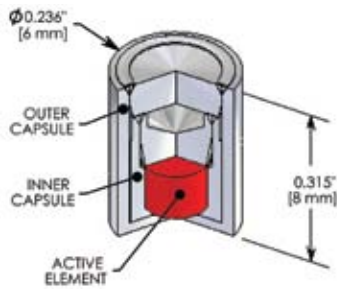

Nominal Activity		Part Numbers	Regulatory
mCi	MBq		
		3015	SS&DR / SFC
0.1	3.7	BA330150100U	Yes / Yes
1	37	BA330150001M	Yes / Yes
5	185	BA330150005M	Yes / Yes
10	370	BA330150010M	Yes / Yes
			Availability: 4 weeks

3024 capsule

Single-encapsulated stainless steel source with 0.01"/0.25mm beryllium window. ISO rating: C66535

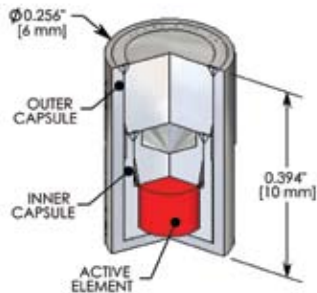

Nominal Activity		Part Numbers	Regulatory
mCi	MBq		
		3024	SS&DR / SFC
0.1	3.7	BA330240100U	Yes / Yes
1	37	BA330240001M	Yes / Yes
5	185	BA330240005M	Yes / Yes
10	370	BA330240010M	Yes / Yes
			Availability: 4-6 weeks

3224 capsule

Single-encapsulated stainless steel source. ISO rating: C66444

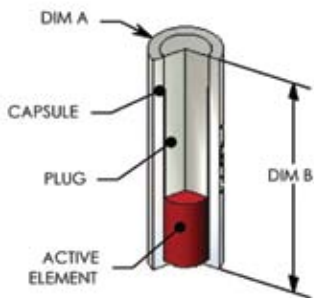

Nominal Activity		Part Numbers	Regulatory
mCi	MBq		
		3224	SS&DR / SFC
0.1	3.7	BA332240100U	Yes / Yes
1	37	BA332240001M	Yes / Yes
5	185	BA332240005M	Yes / Yes
10	370	BA332240010M	Yes / Yes
			Availability: 4-6 weeks

See table on p.71 for available 3224 capsule dimensions.

Am-241
Am-241/Be
Ba-133
Cd-109
Cs-252
Co-57
Co-60
Cs-137
Eu-152
Fe-55
Gd-153
K-85
Mossbauer
Na-22
Ni-63
Pm-147
Ru-106
Sc-75
Sr-90
Yb-169

Ba-133

Standard Capsule Designs

3402 capsule

Double-encapsulated stainless steel line source. Also available in titanium. ISO rating: C33222X

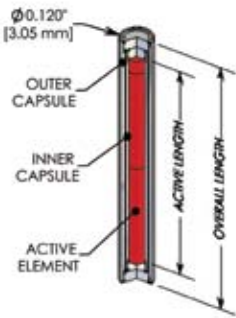

Nominal Activity		Part Numbers	Regulatory
mCi	MBq		
		3402	SS&DR / SFC
0.1	3.7	BA334020100U	Yes / Yes
1	37	BA334020001M	Yes / Yes
5	185	BA334020005M	Yes / Yes
10	370	BA334020010M	Yes / Yes
			Availability: 4 weeks

3902 capsule

Single-encapsulated stainless steel source. ISO rating: C44222

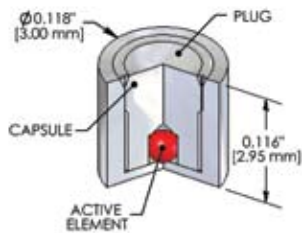

Nominal Activity		Part Numbers	Regulatory
mCi	MBq		
		3902	SS&DR / SFC
0.01	0.37	BA339020010U	Yes / Yes
			Availability: 4 weeks

3916 capsule

Double-encapsulated stainless steel disk source. ISO rating: C33212

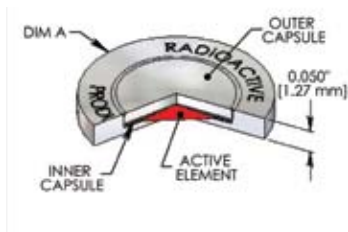

Nominal Activity		Part Numbers	Regulatory
mCi	MBq		
		3916	SS&DR / SFC
0.01	0.37	BA339160010U	Yes / Yes
			Availability: 4 weeks

3916 capsule is available in various diameters: please inquire.



Industrial source manufacturing laboratory in Burbank, CA, USA.

Am-241
Am-241/Be
Ba-133
Cd-109
Cf-252
Co-57
Co-60
Cs-137
Eu-152
Fe-55
Gd-153
Kr-85
Mössbauer
Na-22
Ni-63
Pm-147
Ru-106
Se-75
Sr-90
Yb-169

Cd-109

Standard Capsule Designs

Activity Tolerance

± 15% from nominal

Recommended Working Life

See Technical Information section.

Only typical sources are listed; inquiries are invited for alternative capsule designs and activities.

For Low Energy Gamma and XRF applications, these sources offer a radionuclide with X-ray emissions between 22keV and 26keV contained in a stable, homogeneous active element. For most applications, beryllium window capsules are used.



3204 capsule

Single-encapsulated stainless steel source with 0.010"/0.254mm beryllium window. ISO rating: C43333

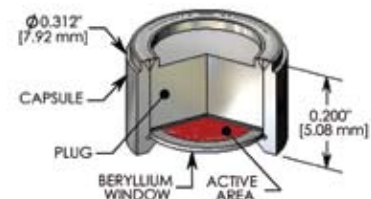

Nominal Activity		Part Numbers	Regulatory
mCi	MBq		
		3204	SS&DR / SFC
1	37	CD932040001M	Yes / Yes
10	370	CD932040010M	Yes / Yes
14	518	CD932040014M	Yes / Yes
20	740	CD932040020M	Yes / Yes
40	1480	CD932040040M	Yes / Yes
			Availability: 4-6 weeks

3205 capsule

Single-encapsulated stainless steel source with 0.040"/1.01mm beryllium window. ISO rating: C43333

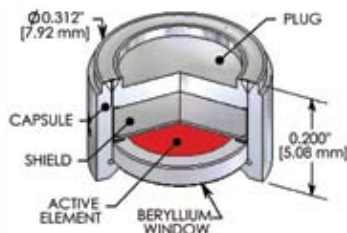

Nominal Activity		Part Numbers	Regulatory
mCi	MBq		
		3205	SS&DR / SFC
1	37	CD932050001M	Yes / No
10	370	CD932050010M	Yes / No
14	518	CD932050014M	Yes / No
20	740	CD932050020M	Yes / No
40	1480	CD932050040M	Yes / No
50	1850	CD932050050M	Yes / No
			Availability: 4-6 weeks

3215 capsule

Single-encapsulated stainless steel source with 0.01"/0.25mm beryllium window. ISO rating: C33222

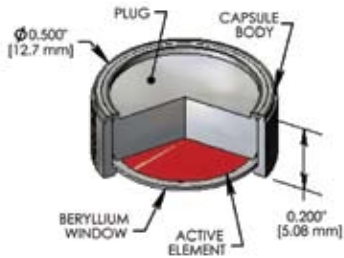

Nominal Activity		Part Numbers	Regulatory
mCi	MBq		
		3215	SS&DR / SFC
1	37	CD932150001M	Yes / No
10	370	CD932150010M	Yes / No
20	740	CD932150020M	Yes / No
50	1850	CD932150050M	Yes / No
Availability: 4-6 weeks			

3236 capsule

Single-encapsulated stainless steel source with 0.04"/1.0mm beryllium window. ISO rating: C54243

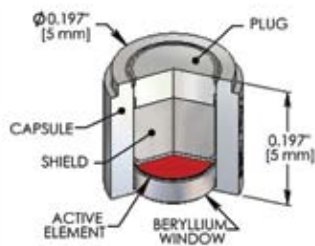

Nominal Activity		Part Numbers	Regulatory
mCi	MBq		
		3236	SS&DR / SFC
1	37	CD932360001M	Yes / No
5	185	CD932360005M	Yes / No
10	370	CD932360010M	Yes / No
Availability: 4-6 weeks			

Am-241
Am-241/Be
Ba-133
Cd-109
Cf-252
Co-57
Co-60
Cs-137
Eu-152
Fe-55
Gd-153
Kr-85
Mossbauer
Na-22
Ni-63
Pm-147
Ru-106
Se-75
Sr-90
Yb-169

CF-252

Standard Capsule Designs

Activity Tolerance

± 15% from nominal

Recommended Working Life

See Technical Information section.

Only typical sources are listed; inquiries are invited for alternative capsule designs and activities.

Spontaneous fission neutron sources for research, moisture gauging and materials analysis applications requiring low activities. Activity is contained in a stable homogeneous element.



3014 capsule

Double-encapsulated stainless steel point source. ISO rating: C66535

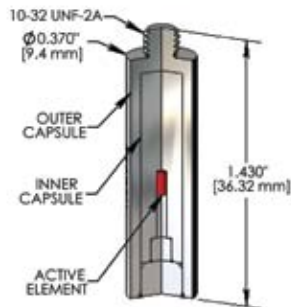

Nominal Activity		Part Numbers	Regulatory
mCi	MBq		
		3014	SS&DR / SFC
0.0001	0.0037	CF230140100N	Yes / No
0.005	0.185	CF230140005U	Yes / No
0.01	0.37	CF230140010U	Yes / No
0.5	18.5	CF230140500U	Yes / No
1	37	CF230140001M	Yes / No
			Availability: 4 weeks

Intermediate activities are available upon request.

3023 capsule

Double-encapsulated stainless steel source. ISO rating: C63333

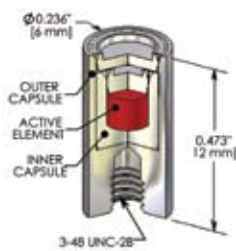

Nominal Activity		Part Numbers	Regulatory
mCi	MBq		
		3023	SS&DR / SFC
0.0001	0.0037	CF230230100N	Yes / Yes
0.005	0.185	CF230230005U	Yes / Yes
0.01	0.37	CF230230010U	Yes / Yes
0.5	18.5	CF230230500U	Yes / Yes
1	37	CF230230001M	Yes / Yes
			Availability: 4 weeks

3024 capsule

Double-encapsulated stainless steel source. ISO rating: C66535

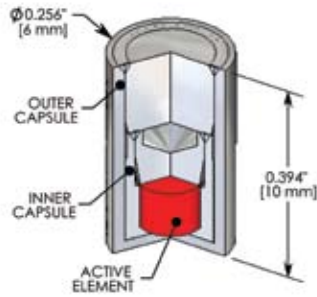

Nominal Activity		Part Numbers	Regulatory
mCi	MBq		
		3024	SS&DR / SFC
0.0001	0.0037	CF230240100N	Yes / Yes
0.005	0.185	CF230240005U	Yes / Yes
0.01	0.37	CF230240010U	Yes / Yes
0.5	18.5	CF230240500U	Yes / Yes
1	37	CF230240001M	Yes / Yes
			Availability: 4 weeks

Intermediate activities are available upon request.

3026 capsule

Triple-encapsulated stainless steel source. ISO rating: C66535

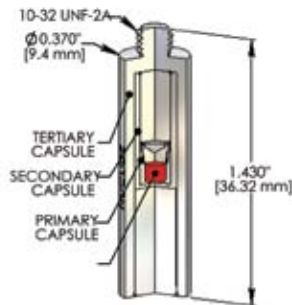

Nominal Activity		Part Numbers	Regulatory
mCi	MBq		
		3026	SS&DR / SFC
0.0001	0.0037	CF230260100N	Yes / Yes
0.005	0.185	CF230260005U	Yes / Yes
0.01	0.37	CF230260010U	Yes / Yes
0.5	18.5	CF230260500U	Yes / Yes
1	37	CF230260001M	Yes / Yes
			Availability: 4 weeks

Intermediate activities are available upon request.

3036 capsule

Double-encapsulated stainless steel source. ISO rating: C66545

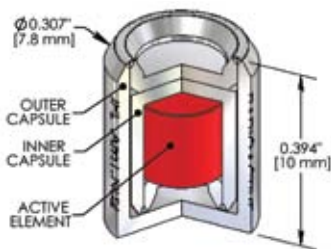

Nominal Activity		Part Numbers	Regulatory
mCi	MBq		
		3036	SS&DR / SFC
0.0001	0.0037	CF230360100N	No / No
0.005	0.185	CF230360005U	No / No
0.01	0.37	CF230360010U	No / No
0.5	18.5	CF230360500U	No / No
1	37	CF230360001M	No / No
			Availability: 4 weeks

Intermediate activities are available upon request.

Am-241
Am-241/Be
Ba-133
Cd-109
CF-252
Co-57
Co-60
Cs-137
Eu-152
Fe-55
Gd-153
Kr-85
Mossbauer
Na-22
Ni-63
Pm-147
Ra-106
Se-75
Sr-90
Yb-169

Co-57

Standard Capsule Designs

Activity Tolerance

± 15% from nominal

Recommended Working Life

See Technical Information section.

Only typical sources are listed; inquiries are invited for alternative capsule designs and activities.

For Low Energy Gamma applications, these sources offer a radionuclide in a stable, homogeneous active element, with main gamma emissions at 122keV and 136keV. The lower energy emissions are enhanced when beryllium window capsules are used.



3000 capsule

Double-encapsulated stainless steel source. ISO rating: C66535

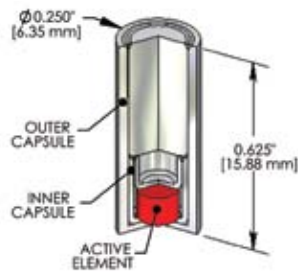

Nominal Activity		Part Numbers	Regulatory
mCi	MBq		
		3000	SS&DR / SFC
0.5	18.5	C0730000500U	Yes / Yes
1	37	C0730000001M	Yes / Yes
5	185	C0730000005M	Yes / Yes
10	370	C0730000010M	Yes / Yes
25	925	C0730000025M	Yes / Yes
50	1850	C0730000050M	Yes / Yes
100	3700	C0730000100M	Yes / Yes

Availability: 4-6 weeks

3024 capsule

Double-encapsulated stainless steel source. ISO rating: C66535

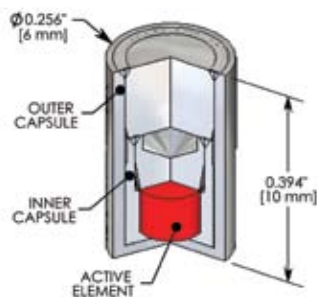

Nominal Activity		Part Numbers	Regulatory
mCi	MBq		
		3024	SS&DR / SFC
0.5	18.5	C0730240500U	Yes / Yes
1	37	C0730240001M	Yes / Yes
5	185	C0730240005M	Yes / Yes
10	370	C0730240010M	Yes / Yes
25	925	C0730240025M	Yes / Yes
50	1850	C0730240050M	Yes / Yes
100	3700	C0730240100M	Yes / Yes

Availability: 4-6 weeks

3025 capsule

Single-encapsulated stainless steel source. ISO rating: C66434

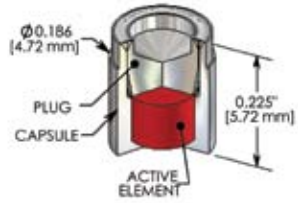

Nominal Activity		Part Numbers	Regulatory
mCi	MBq		
		3025	SS&DR / SFC
0.5	18.5	C0730250500U	Yes / Yes
1	37	C0730250001M	Yes / Yes
5	185	C0730250005M	Yes / Yes
10	370	C0730250010M	Yes / Yes
25	925	C0730250025M	Yes / Yes
50	1850	C0730250050M	Yes / Yes
100	3700	C0730250100M	Yes / Yes
			Availability: 4-6 weeks

3201 capsule

Single-encapsulated stainless steel source. ISO rating: C66545

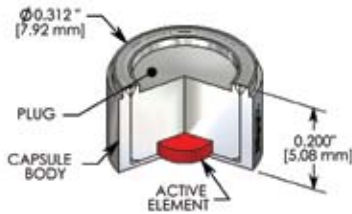

Nominal Activity		Part Numbers	Regulatory
mCi	MBq		
		3201	SS&DR / SFC
0.5	18.5	C0732010500U	Yes / Yes
1	37	C0732010001M	Yes / Yes
5	185	C0732010005M	Yes / Yes
10	370	C0732010010M	Yes / Yes
25	925	C0732010025M	Yes / Yes
50	1850	C0732010050M	Yes / Yes
100	3700	C0732010100M	Yes / Yes
			Availability: 4-6 weeks

3202 capsule

Single-encapsulated stainless steel source. ISO rating: C66545

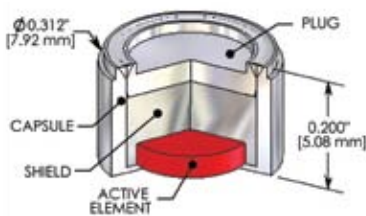

Nominal Activity		Part Numbers	Regulatory
mCi	MBq		
		3202	SS&DR / SFC
0.5	18.5	C0732020500U	Yes / Yes
1	37	C0732020001M	Yes / Yes
5	185	C0732020005M	Yes / Yes
10	370	C0732020010M	Yes / Yes
25	925	C0732020025M	Yes / Yes
50	1850	C0732020050M	Yes / Yes
100	3700	C0732020100M	Yes / Yes
			Availability: 4-6 weeks

Am-241
Am-241/Be
Ba-133
Cd-109
Cs-137
Co-57
Co-60
Cs-137
Eu-152
Fe-55
Gd-153
K-85
Mössbauer
Na-22
Ni-63
Pm-147
Ra-106
Se-75
Sr-90
Yb-169

Co-57

Standard Capsule Designs

3204 capsule

Single-encapsulated stainless steel source with 0.01"/0.25mm beryllium window. ISO rating: C43333

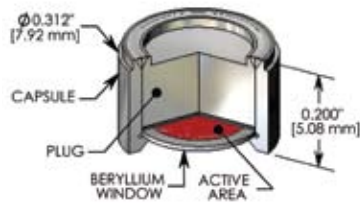

Nominal Activity		Part Numbers	Regulatory
mCi	MBq		
		3204	SS&DR / SFC
0.5	18.5	C0732040500U	Yes / Yes
1	37	C0732040001M	Yes / Yes
5	185	C0732040005M	Yes / Yes
10	370	C0732040010M	Yes / Yes
25	925	C0732040025M	Yes / Yes
50	1850	C0732040050M	Yes / Yes
100	3700	C0732040100M	Yes / Yes
			Availability: 4-6 weeks

3205 capsule

Single-encapsulated stainless steel source with 0.04"/1.0mm beryllium window. ISO rating: C43333

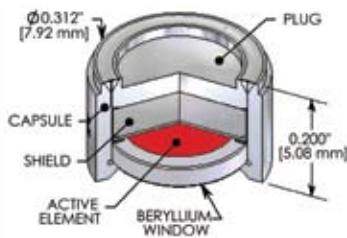

Nominal Activity		Part Numbers	Regulatory
mCi	MBq		
		3205	SS&DR / SFC
0.5	18.5	C0732050500U	Yes / No
1	37	C0732050001M	Yes / No
5	185	C0732050005M	Yes / No
10	370	C0732050010M	Yes / No
25	925	C0732050025M	Yes / No
50	1850	C0732050050M	Yes / No
100	3700	C0732050100M	Yes / No
			Availability: 4-6 weeks

3215 capsule

Single-encapsulated stainless steel source with beryllium window. ISO rating: C33222

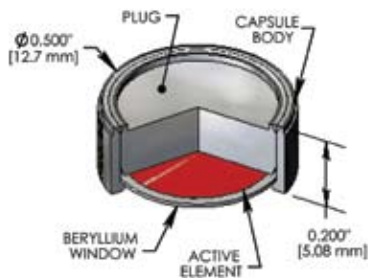

Nominal Activity		Part Numbers	Regulatory
mCi	MBq		
		3215	SS&DR / SFC
0.5	18.5	C0732150500U	Yes / No
1	37	C0732150001M	Yes / No
5	185	C0732150005M	Yes / No
10	370	C0732150010M	Yes / No
25	925	C0732150025M	Yes / No
50	1850	C0732150050M	Yes / No
100	3700	C0732150100M	Yes / No
			Availability: 4-6 weeks

3224 capsule

Single-encapsulated stainless steel source. ISO rating: C66444

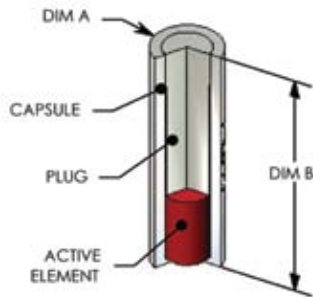

Nominal Activity		Part Numbers	Regulatory
mCi	MBq		
		3224	SS&DR / SFC
0.5	18.5	C0732240500U	Yes / Yes
1	37	C0732240001M	Yes / Yes
5	185	C0732240005M	Yes / Yes
10	370	C0732240010M	Yes / Yes
25	925	C0732240025M	Yes / Yes
50	1850	C0732240050M	Yes / Yes
100	3700	C0732240100M	Yes / Yes

Availability: 4-6 weeks

See table on p.71 for available 3224 capsule dimensions.

3402 capsule

Double-encapsulated stainless steel line source. Also available in titanium. ISO rating: C33222X

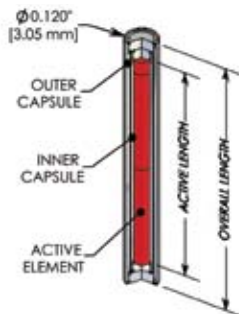

Nominal Activity		Part Numbers	Regulatory
mCi	MBq		
		3402	SS&DR / SFC
0.5	18.5	C0734020500U	Yes / Yes
1	37	C0734020001M	Yes / Yes
5	185	C0734020005M	Yes / Yes
10	370	C0734020010M	Yes / Yes
25	925	C0734020025M	Yes / Yes
50	1850	C0734020050M	Yes / Yes
100	3700	C0734020100M	Yes / Yes

Availability: 4-6 weeks

3807 capsule

Single-encapsulated stainless steel point source. ISO rating: C66444

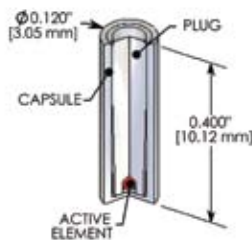

Nominal Activity		Part Numbers	Regulatory
mCi	MBq		
		3807	SS&DR / SFC
0.5	18.5	C0738070500U	Yes / No
1	37	C0738070001M	Yes / No
5	185	C0738070005M	Yes / No
10	370	C0738070010M	Yes / No
25	925	C0738070025M	Yes / No
50	1850	C0738070050M	Yes / No
100	3700	C0738070100M	Yes / No

Availability: 4-6 weeks

Am-241
Am-241/Be
Ba-133
Cd-109
Cf-252
Co-57
Co-60
Cs-137
Eu-152
Fe-55
Gd-153
Kr-85
Mossbauer
Na-22
Ni-63
Pm-147
Ra-106
Sc-75
Sr-90
Yb-169

Co-60

Standard Capsule Designs

Activity Tolerance

± 15% from nominal

Recommended Working Life

See Technical Information section.

Only typical sources are listed; inquiries are invited for alternative capsule designs and activities.

These High Energy Gamma sources incorporate a stable, homogeneous active element and offer a radionuclide with distinct gamma emissions of 1173keV and 1333keV.



3000 capsule

Double-encapsulated stainless steel source. ISO rating: C66535

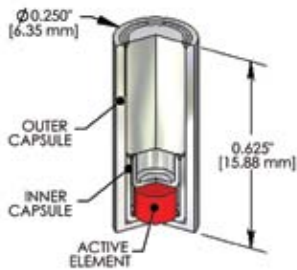

Nominal Activity		Part Numbers	Regulatory
mCi	MBq		
		3000	SS&DR / SFC
0.1	3.7	CO030000100U	Yes / Yes
0.5	18.5	CO030000500U	Yes / Yes
1	37	CO030000001M	Yes / Yes
5	185	CO030000005M	Yes / Yes
10	370	CO030000010M	Yes / Yes
50	1850	CO030000050M	Yes / Yes
100	3700	CO030000100M	Yes / Yes

Availability: up to 5mCi (185MBq) 4 weeks; higher activities 8 weeks

3011 capsule

Double-encapsulated stainless steel source. ISO rating: C66545

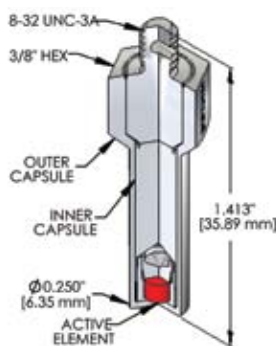

Nominal Activity		Part Numbers	Regulatory
mCi	MBq		
		3011	SS&DR / SFC
0.1	3.7	CO030110100U	Yes / Yes
0.5	18.5	CO030110500U	Yes / Yes
1	37	CO030110001M	Yes / Yes
5	185	CO030110005M	Yes / Yes
10	370	CO030110010M	Yes / Yes
50	1850	CO030110050M	Yes / Yes
100	3700	CO030110100M	Yes / Yes

Availability: up to 5mCi (185MBq) 4 weeks; higher activities 8 weeks

3015 capsule

Double-encapsulated stainless steel source. ISO rating: C66535

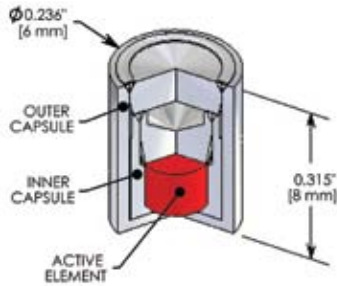

Nominal Activity		Part Numbers	Regulatory
mCi	MBq		
		3015	SS&DR / SFC
0.1	3.7	CO030150100U	Yes / Yes
1	37	CO030150001M	Yes / Yes
5	185	CO030150005M	Yes / Yes
10	370	CO030150010M	Yes / Yes
50	1850	CO030150050M	Yes / Yes
100	3700	CO030150100M	Yes / Yes
500	18500	CO030150500M	Yes / Yes

Availability: up to 5mCi (185MBq) 4 weeks; higher activities 8 weeks

3025 capsule

Single-encapsulated stainless steel source. ISO rating: C66434

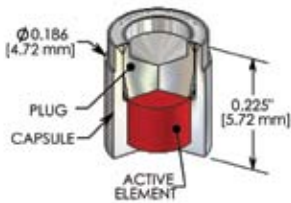

Nominal Activity		Part Numbers	Regulatory
mCi	MBq		
		3025	SS&DR / SFC
0.1	3.7	CO030250100U	Yes / No
1	37	CO030250001M	Yes / No
5	185	CO030250005M	Yes / No
10	370	CO030250010M	Yes / No
50	1850	CO030250050M	Yes / No
100	3700	CO030250100M	Yes / No
500	18500	CO030250500M	Yes / No

Availability: up to 5mCi (185MBq) 4 weeks; higher activities 8 weeks

3026 capsule

Triple-encapsulated stainless steel source. ISO rating: C66535

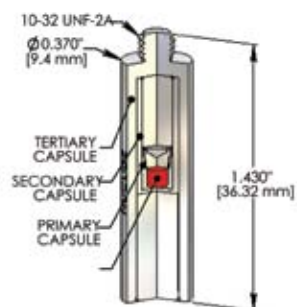

Nominal Activity		Part Numbers	Regulatory
mCi	MBq		
		3026	SS&DR / SFC
0.1	3.7	CO030260100U	Yes / No
1	37	CO030260001M	Yes / No
5	185	CO030260005M	Yes / No
10	370	CO030260010M	Yes / No
50	1850	CO030260050M	Yes / No
100	3700	CO030260100M	Yes / No
500	18500	CO030260500M	Yes / No

Availability: up to 5mCi (185MBq) 4 weeks; higher activities 8 weeks

Am-241
Am-241/Be
Ba-133
Cd-109
Cs-137
Cs-137
Eu-152
Eu-152
Fe-55
Gd-153
Gd-153
K-85
K-85
Mössbauer
Na-22
Ni-63
Ni-63
Pm-147
Pm-147
Ra-106
Ra-106
Sc-75
Sc-75
Sr-90
Sr-90
Yb-169
Yb-169

Co-60

Standard Capsule Designs

3044 capsule

Double-encapsulated stainless steel source. ISO rating: C66646

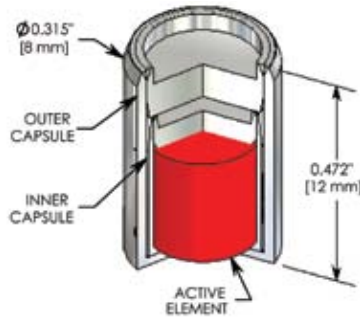

Nominal Activity		Part Numbers	Regulatory
mCi	MBq		
		3044	SS&DR / SFC
0.1	3.7	C0030440100U	Yes / Yes
1	37	C0030440001M	Yes / Yes
10	370	C0030440010M	Yes / Yes
100	3700	C0030440100M	Yes / Yes
1000	37000	C0030440001C	Yes / Yes
4000	148000	C0030440004C	Yes / Yes

Availability: up to 5mCi (185MBq) 4 weeks; higher activities 8 weeks

3224 capsule

Single-encapsulated stainless steel source. ISO rating: C66444

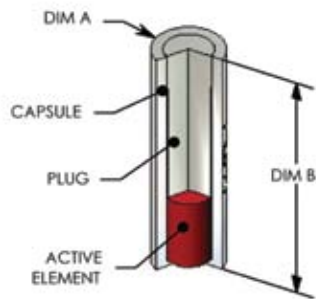

Nominal Activity		Part Numbers	Regulatory
mCi	MBq		
		3224	SS&DR / SFC
0.005	0.37	C0032240005U	Yes / Yes
0.01	3.33	C0032240010U	Yes / Yes
0.05	3.7	C0032240050U	Yes / Yes
0.1	18.5	C0032240100U	Yes / Yes
0.5	37	C0032240500U	Yes / Yes
1	185	C0032240001M	Yes / Yes
5	370	C0032240005M	Yes / Yes

Availability: 4 weeks

See table on p.71 for available 3224 capsule dimensions.

3402 capsule

Double-encapsulated stainless steel line source. Also available in titanium. ISO rating: C33222X

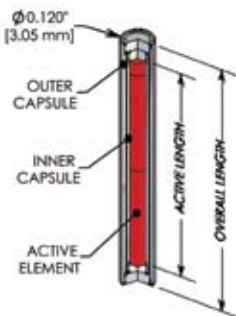

Nominal Activity		Part Numbers	Regulatory
mCi	MBq		
		3402	SS&DR / SFC
0.1	3.7	C0034020100U	Yes / Yes
0.5	18.5	C0034020500U	Yes / Yes
1	37	C0034020001M	Yes / Yes
5	185	C0034020005M	Yes / Yes
10	370	C0034020010M	Yes / Yes

Availability: 4-6 weeks

P03 capsule

Double-encapsulated stainless steel source. ISO rating: C65545

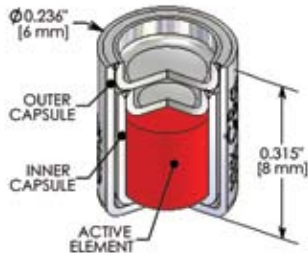

Nominal Activity		Part Numbers	Regulatory
mCi	MBq		
		P03	SS&DR / SFC
10	370	COOP030010M	No / No
50	1850	COOP030050M	No / No
100	3700	COOP030100M	No / No
500	18500	COOP030500M	No / No
1000	37000	COOP030001C	No / No
			Availability: 8 weeks

P04 capsule

Double-encapsulated stainless steel source. ISO rating: C66646

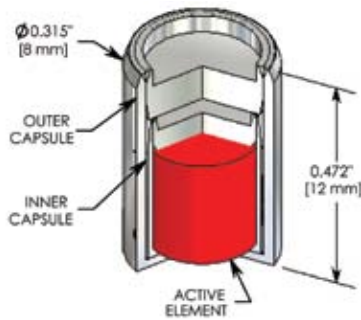

Nominal Activity		Part Numbers	Regulatory
mCi	MBq		
		P04	SS&DR / SFC
10	370	COOP040010M	Yes / Yes
50	1850	COOP040050M	Yes / Yes
100	3700	COOP040100M	Yes / Yes
500	18500	COOP040500M	Yes / Yes
1000	37000	COOP040001C	Yes / Yes
			Availability: 8 weeks

P17 capsule

Double-encapsulated stainless steel source. ISO rating: C66646

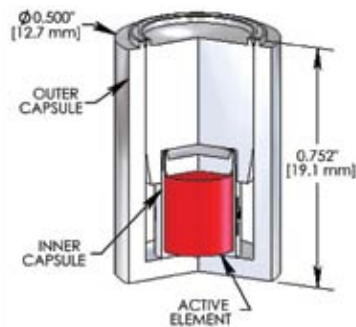

Nominal Activity		Part Numbers	Regulatory
mCi	GHq		
		P17	SS&DR / SFC
50	1.85	COOP170050M	Yes / Yes
100	3.7	COOP170100M	Yes / Yes
500	18.5	COOP170500M	Yes / Yes
1000	37.0	COOP170001C	Yes / Yes
2000	74.0	COOP170002C	Yes / Yes
4000	148	COOP170004C	Yes / Yes
			Availability: 8 weeks

Am-241
Am-241/Be
Ba-133
Cd-109
Cs-137
Cs-137
Eu-152
Fe-55
Gd-153
K-85
Mössbauer
Na-22
Ni-63
Pm-147
Ra-106
Sc-75
Sr-90
Yb-169

Co-60

Standard Capsule Designs

P17-1 capsule

Double-encapsulated stainless steel source; stable, homogeneous active element. ISO rating: C66646

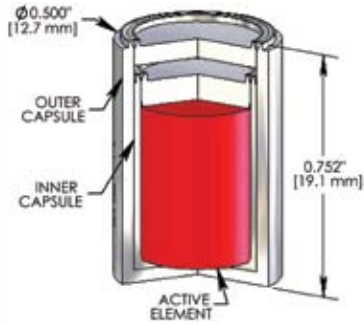

Nominal Activity		Part Numbers	Regulatory
mCi	MBq	P17-1	SS&DR / SFC
50	1.85	COOP17-10050M	Yes / Yes
100	3.7	COOP17-10100M	Yes / Yes
500	18.5	COOP17-10500M	Yes / Yes
1000	37.0	COOP17-10001C	Yes / Yes
2000	74.0	COOP17-10002C	Yes / Yes
4000	148	COOP17-10004C	Yes / Yes
			Availability: 8 weeks



Eckert & Ziegler Isotope Products performs leakage tests on each source according to the ISO 9978 standard.

Am-241
Am-241/Be
Ba-133
Cd-109
Cf-252
Co-57
Co-60
Cs-137
Eu-152
Fe-55
Gd-153
Kr-85
Mossbauer
Na-22
Ni-63
Pm-147
Ru-106
Se-75
Sr-90
Yb-169

Cs-137

Standard Capsule Designs

Activity Tolerance

± 15% from nominal

Recommended Working Life

See Technical Information section.

Only typical sources are listed; inquiries are invited for alternative capsule designs and activities.

Supplied as a stable, homogeneous active element, for High Energy Gamma applications, these Sources offer a radionuclide with a distinct gamma emission at 662keV.



3000 capsule

Double-encapsulated stainless steel source. ISO rating: C66535

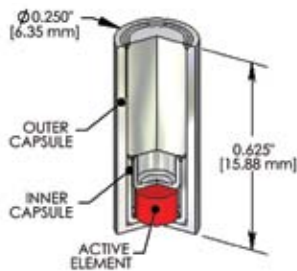

Nominal Activity		Part Numbers	Regulatory
mCi	MBq	3000	SS&DR / SFC
0.005	0.185	CS730000005U	Yes / Yes
0.1	3.7	CS730000100U	Yes / Yes
1	37	CS730000001M	Yes / Yes
10	370	CS730000010M	Yes / Yes
50	1850	CS730000050M	Yes / Yes
100	3700	CS730000100M	Yes / Yes
250	9250	CS730000250M	Yes / Yes

Availability: up to 10mCi (370MBq) 4 weeks; higher activities 8 weeks

3011 capsule

Double-encapsulated stainless steel source. ISO rating: C66545

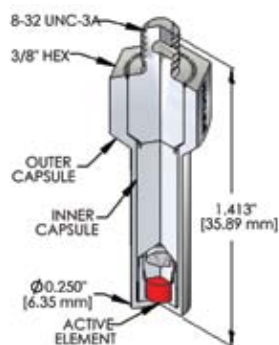

Nominal Activity		Part Numbers	Regulatory
mCi	MBq	3011	SS&DR / SFC
0.005	0.185	CS730110005U	Yes / Yes
0.1	3.7	CS730110100U	Yes / Yes
1	37	CS730110001M	Yes / Yes
10	370	CS730110010M	Yes / Yes
50	1850	CS730110050M	Yes / Yes
100	3700	CS730110100M	Yes / Yes
250	9250	CS730110250M	Yes / Yes

Availability: up to 10mCi (370MBq) 4 weeks; higher activities 8 weeks

3015 capsule

Double-encapsulated stainless steel source. ISO rating: C66535

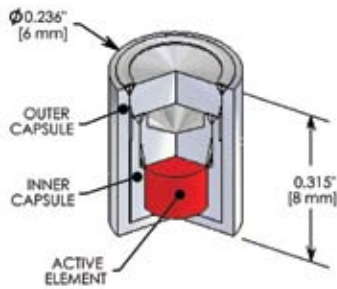

Nominal Activity		Part Numbers	Regulatory
mCi	MBq		
		3015	SS&DR / SFC
0.005	0.185	CS730150005U	Yes / Yes
0.1	3.7	CS730150100U	Yes / Yes
1	37	CS730150001M	Yes / Yes
10	370	CS730150010M	Yes / Yes
50	1850	CS730150050M	Yes / Yes
100	3700	CS730150100M	Yes / Yes
250	9250	CS730150250M	Yes / Yes

Availability: up to 10mCi (370MBq) 4 weeks; higher activities 8 weeks

3024 capsule

Double-encapsulated stainless steel source. ISO rating: C66535

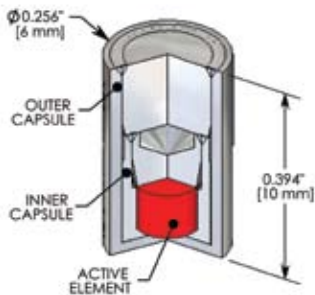

Nominal Activity		Part Numbers	Regulatory
mCi	MBq		
		3024	SS&DR / SFC
0.00005	0.00185	CS730240050N	Yes / Yes
0.005	0.185	CS730240005U	Yes / Yes
0.1	3.7	CS730240100U	Yes / Yes
1	37	CS730240001M	Yes / Yes
10	370	CS730240010M	Yes / Yes
50	1850	CS730240050M	Yes / Yes
100	3700	CS730240100M	Yes / Yes
500	18500	CS730240500M	Yes / Yes

Availability: up to 10mCi (370MBq) 4 weeks; higher activities 8 weeks

3025 capsule

Single-encapsulated stainless steel source. ISO rating: C66434

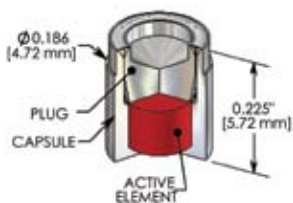

Nominal Activity		Part Numbers	Regulatory
mCi	MBq		
		3025	SS&DR / SFC
0.00005	0.00185	CS730250050N	Yes / No
0.005	0.185	CS730250005U	Yes / No
0.1	3.7	CS730250100U	Yes / No
1	37	CS730250001M	Yes / No
10	370	CS730250010M	Yes / No
50	1850	CS730250050M	Yes / No
100	3700	CS730250100M	Yes / No

Availability: up to 10mCi (370MBq) 4 weeks; higher activities 8 weeks

Am-241
Am-241/Be
Ba-133
Cd-109
Cs-137
Cs-137
Eu-152
Fe-55
Gd-153
K-85
Mössbauer
Na-22
Ni-63
Pm-147
Ra-106
Sc-75
Sr-90
Yb-169

Cs-137

Standard Capsule Designs

3201 capsule

Single-encapsulated stainless steel source. ISO rating: C66545

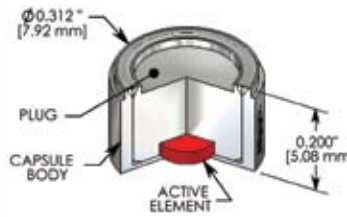

Nominal Activity		Part Numbers	Regulatory
mCi	MBq		
		3201	SS&DR / SFC
0.00005	0.00185	CS732010050N	Yes / Yes
0.005	0.185	CS732010005U	Yes / Yes
0.1	3.7	CS732010100U	Yes / Yes
1	37	CS732010001M	Yes / Yes
10	370	CS732010010M	Yes / Yes
50	1850	CS732010050M	Yes / Yes
100	3700	CS732010100M	Yes / Yes

Availability: up to 10mCi (370MBq) 4 weeks; higher activities 8 weeks

3224 capsule

Single-encapsulated stainless steel source. ISO rating: C66444

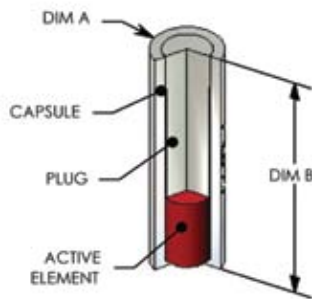

Nominal Activity		Part Numbers	Regulatory
mCi	MBq		
		3224	SS&DR / SFC
0.005	0.185	CS732240005U	Yes / Yes
0.01	0.37	CS73224010U	Yes / Yes
0.05	1.85	CS732240050U	Yes / Yes
0.1	3.7	CS732240100U	Yes / Yes
0.5	18.5	CS732240500U	Yes / Yes
1	37	CS732240001M	Yes / Yes
5	185	CS732240005M	Yes / Yes

Availability: 4 weeks

See table on p.71 for available 3224 capsule dimensions.

3402 capsule

Double-encapsulated stainless steel line source. Also available in titanium. ISO rating: C33222X

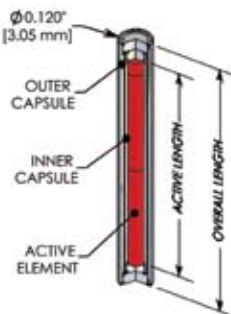

Nominal Activity		Part Numbers	Regulatory
mCi	MBq		
		3402	SS&DR / SFC
0.1	3.7	CS734020100U	Yes / Yes
0.5	18.5	CS734020500U	Yes / Yes
1	37	CS732240001M	Yes / Yes
5	185	CS734020005M	Yes / Yes
10	370	CS734020010M	Yes / Yes
50	1850	CS734020050M	Yes / Yes
100	3700	CS734020100M	Yes / Yes

Availability: up to 10mCi (370MBq) 4 weeks; higher activities 8 weeks

3888 capsule

Single-encapsulated stainless steel disk source. ISO rating: C22212

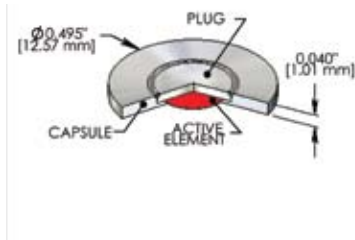

Nominal Activity		Part Numbers	Regulatory
mCi	MBq		
		3888	SS&DR / SFC
0.000084	0.0031	CS7A38880084N	Yes / No
0.0001	0.0037	CS7A38880100N	Yes / No
0.001	0.037	CS7A38880001U	Yes / No
0.01	0.37	CS7A38880010U	Yes / No
0.1	3.7	CS7A38880100U	Yes / No
1	37	CS7A38880001M	Yes / No
			Availability: 4 weeks

3916 capsule

Double-encapsulated stainless steel disk source. ISO rating: C22212

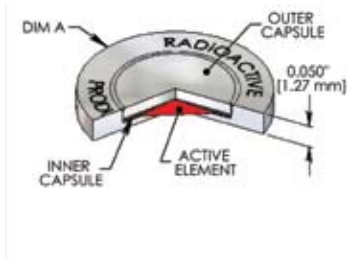

Nominal Activity		Part Numbers	Regulatory
mCi	MBq		
		3916	SS&DR / SFC
0.000084	0.0031	CS7A39160084N	Yes / No
0.0001	0.0037	CS7A39160100N	Yes / No
0.001	0.037	CS7A39160001U	Yes / No
0.01	0.37	CS7A39160010U	Yes / No
0.1	3.7	CS7A39160100U	Yes / No
1	37	CS7A39160001M	Yes / No
			Availability: 4 weeks

3916 capsule is available in various diameters: please inquire.

P01 capsule

Double-encapsulated stainless steel source. ISO rating: C66646

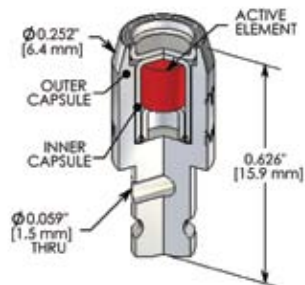

Nominal Activity		Part Numbers	Regulatory
mCi	MBq		
		P01	SS&DR / SFC
0.5	18.5	CS7P010500U	Yes / Yes
1	37	CS7P010001M	Yes / Yes
5	185	CS7P010005M	Yes / Yes
			Availability: 8-10 weeks

Am-241
Am-241/Be
Ba-133
Gd-109
Cr-252
Co-57
Co-60
Cs-137
Eu-152
Fe-55
Gd-153
Kr-85
Mossbauer
Na-22
Ni-63
Pm-147
Ru-106
Sc-75
Sr-90
Yb-169

Cs-137

Standard Capsule Designs

P02 capsule

Double-encapsulated stainless steel source. ISO rating: C66646

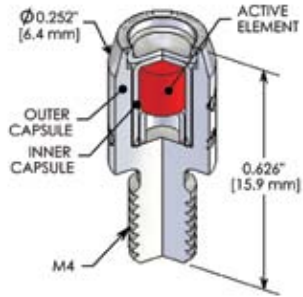

Nominal Activity		Part Numbers	Regulatory
mCi	MBq		
		P02	SS&DR / SFC
0.5	18.5	CS7P020500U	Yes / Yes
1	37	CS7P020001M	Yes / Yes
5	185	CS7P020005M	Yes / Yes
10	370	CS7P020010M	Yes / Yes
50	1850	CS7P020050M	Yes / Yes
100	3700	CS7P020100M	Yes / Yes
250	9250	CS7P020250M	Yes / Yes
Availability: 8-10 weeks			

P03 capsule

Double-encapsulated stainless steel source. ISO rating: C65445

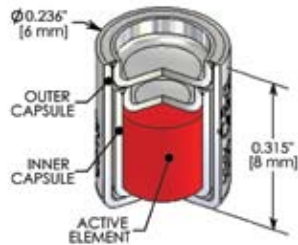

Nominal Activity		Part Numbers	Regulatory
mCi	MBq		
		P03	SS&DR / SFC
0.5	18.5	CS7P030500U	Yes / Yes
1	37	CS7P030001M	Yes / Yes
5	185	CS7P030005M	Yes / Yes
10	370	CS7P030010M	Yes / Yes
50	1850	CS7P030050M	Yes / Yes
100	3700	CS7P030100M	Yes / Yes
250	9250	CS7P030250M	Yes / Yes
500	18500	CS7P030500M	Yes / Yes
Availability: 8-10 weeks			

P04 capsule

Double-encapsulated stainless steel source. ISO rating: C66646

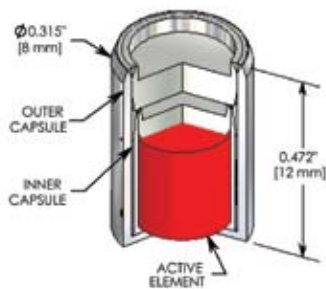

Nominal Activity		Part Numbers	Regulatory
mCi	MBq		
		P04	SS&DR / SFC
1	37	CS7P040001M	Yes / Yes
10	370	CS7P040010M	Yes / Yes
100	3700	CS7P040100M	Yes / Yes
500	18500	CS7P040500M	Yes / Yes
750	27750	CS7P040750M	Yes / Yes
1000	37000	CS7P041000M	Yes / Yes
1500	65000	CS7P041500M	Yes / Yes
Availability: 8-10 weeks			

Also available as P04-A capsule with M6 threaded stud. Inquire for details.

P05 capsule

Double-encapsulated stainless steel source. ISO rating: C66646

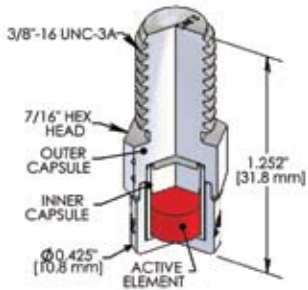

Nominal Activity		Part Numbers	Regulatory
mCi	MBq		
		P04	SS&DR / SFC
500	18500	CS7P050500M	Yes / Yes
1000	37000	CS7P050001C	Yes / Yes
2000	74000	CS7P050002C	Yes / Yes
3000	111000	CS7P0500003C	Yes / Yes
			Availability: 8-10 weeks

P13 capsule

Double-encapsulated stainless steel source. ISO rating: C66646

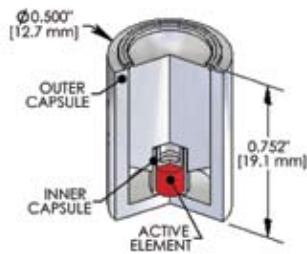

Nominal Activity		Part Numbers	Regulatory
mCi	MBq		
		P13	SS&DR / SFC
1	37	CS7P130001M	Yes / Yes
2	74	CS7P130002M	Yes / Yes
5	185	CS7P130005M	Yes / Yes
10	370	CS7P130010M	Yes / Yes
50	1850	CS7P130050M	Yes / Yes
100	3700	CS7P130100M	Yes / Yes
			Availability: 8-10 weeks

Note: Activity tolerance: +20/-15%

Am-241
Am-241/Be
Ba-133
Cd-109
Cf-252
Co-57
Co-60
Cs-137
Eu-152
Fe-55
Gd-153
Kr-85
Mossbauer
Na-22
Ni-63
Pm-147
Ru-106
Se-75
Sr-90
Yb-169

Cs-137

Standard Capsule Designs

P17 capsule

Double-encapsulated stainless steel source. ISO rating: C66646

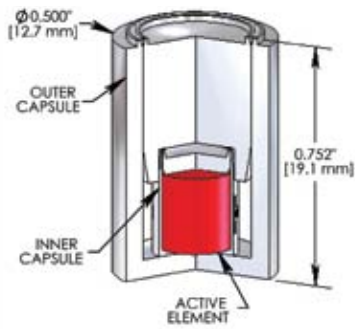

Nominal Activity		Part Numbers	Regulatory
mCi	MBq		
		P17	SS&DR / SFC
1	37	CS7P170001M	Yes / Yes
10	370	CS7P170010M	Yes / Yes
100	3700	CS7P170100M	Yes / Yes
500	18500	CS7P170500M	Yes / Yes
750	27750	CS7P170750M	Yes / Yes
1000	37000	CS7P170001C	Yes / Yes
2000	74000	CS7P170002C	Yes / Yes

Availability: 8-10 weeks

Note: Activity tolerance: +20/-15%

P17-1 capsule

Double-encapsulated stainless steel source. ISO rating: C66646

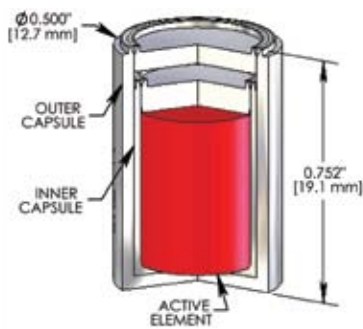

Nominal Activity		Part Numbers	Regulatory
mCi	GBq		
		P17-1	SS&DR / SFC
1000	37	CS7P17-10001C	Yes / Yes
2000	74	CS7P17-10002C	Yes / Yes
4000	148	CS7P17-10004C	Yes / Yes
6000	222	CS7P17-10006C	Yes / Yes
8000	296	CS7P17-10008C	Yes / Yes
10000	370	CS7P17-10010C	Yes / Yes

Availability: up to 6000mCi (222GBq) 8-10 weeks; please inquire for higher activities.

Note: Activity tolerance: +20/-15%

P20 capsule

Double-encapsulated stainless steel source. ISO rating: C66646

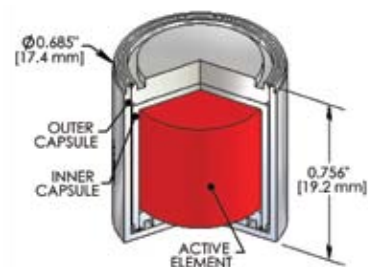

Nominal Activity		Part Numbers	Regulatory
mCi	MBq		
		P20	SS&DR / SFC
1000	37	CS7P200001C	Yes / Yes
2000	74	CS7P200002C	Yes / Yes
4000	148	CS7P200004C	Yes / Yes
6000	222	CS7P200006C	Yes / Yes
8000	296	CS7P200008C	Yes / Yes
10000	370	CS7P200010C	Yes / Yes

Availability: up to 6000mCi (222GBq) 8-10 weeks; please inquire for higher activities.

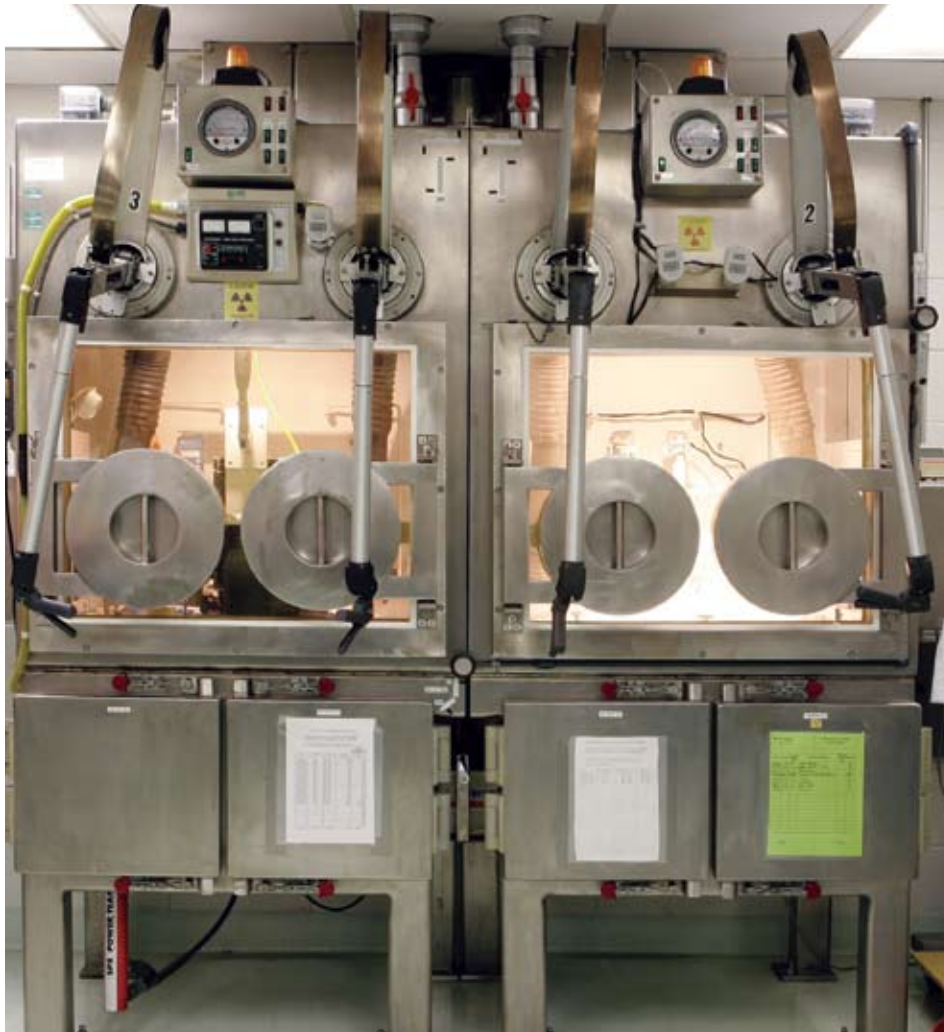

Eckert & Ziegler Isotope Products radiochemistry facilities used in the production of low-energy gamma sources.

Am-241
Am-241/Be
Ba-133
Cd-109
Cf-252
Co-57
Co-60
Cs-137
Eu-152
Fe-55
Gd-153
Kr-85
Mössbauer
Nb-22
Ni-63
Pm-147
Ru-106
Sc-75
Sr-90
Yb-169

Eu-152

Standard Capsule Designs

Activity Tolerance

± 15% from nominal

Recommended Working Life

See Technical Information section.

Only typical sources are listed; inquiries are invited for alternative capsule designs and activities.

For High Energy Gamma applications requiring a long half-life radionuclide, these sources offer a broad gamma spectrum between 122keV and ~1408keV. The activity is contained in a stable, homogeneous active element.



3000 capsule

Double-encapsulated stainless steel source. ISO rating: C66535

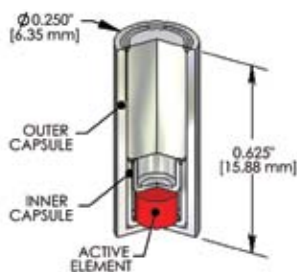

Nominal Activity		Part Numbers	Regulatory
mCi	MBq	3000	SS&DR / SFC
0.1	3.7	EU230000100U	Yes / Yes
0.25	9.25	EU230000250U	Yes / Yes
0.5	18.5	EU230000500U	Yes / Yes
1	37	EU230000001M	Yes / Yes
5	185	EU230000005M	Yes / Yes
10	370	EU230000010M	Yes / Yes
20	740	EU230000020M	Yes / Yes
			Availability: 8 weeks

3011 capsule

Double-encapsulated stainless steel source. ISO rating: C66545

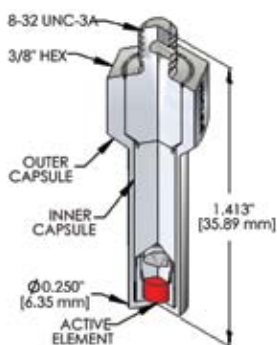

Nominal Activity		Part Numbers	Regulatory
mCi	MBq	3011	SS&DR / SFC
0.1	3.7	EU230110100U	Yes / Yes
0.25	9.25	EU230110250U	Yes / Yes
0.5	18.5	EU230110500U	Yes / Yes
1	37	EU230110001M	Yes / Yes
5	185	EU230110005M	Yes / Yes
10	370	EU230110010M	Yes / Yes
20	740	EU230110020M	Yes / Yes
			Availability: 8 weeks

Eu-152

Standard Capsule Designs

3402 capsule

Double-encapsulated stainless steel line source. Also available in titanium. ISO rating: C33222X

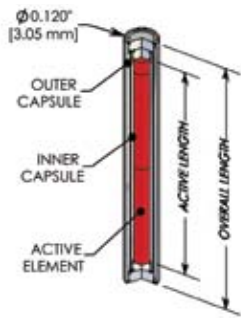

Nominal Activity		Part Numbers	Regulatory
mCi	MBq		
		3402	SS&DR / SFC
0.1	3.7	EU234020100U	Yes / Yes
0.25	9.25	EU234020250U	Yes / Yes
0.5	18.5	EU234020500U	Yes / Yes
1	37	EU234020001M	Yes / Yes
5	185	EU234020005M	Yes / Yes
10	370	EU234020010M	Yes / Yes
20	740	EU234020020M	Yes / Yes
			Availability: 8 weeks



Eckert & Ziegler Isotope Products precisely measures the output of each source prior to dispatch.

Am-241
Am-241/Be
Ba-133
Cd-109
Cf-252
Co-57
Co-60
Cs-137
Eu-152
Fe-55
Gd-153
Kr-85
Mosbauer
Na-22
Ni-63
Pm-147
Ru-106
Se-75
Sr-90
Yb-169

Fe-55

Standard Capsule Designs

Activity Tolerance

± 15% from nominal

Recommended Working Life

See Technical Information section.

Only typical sources are listed; inquiries are invited for alternative capsule designs and activities.

For Low Energy X-ray applications, these sources offer a radionuclide with X-ray emissions around 6keV. Beryllium window capsules are normally used to enhance the low energy emissions. The activity is contained in a stable, homogeneous active element.



3204 capsule

Single-encapsulated stainless steel source with 0.01"/0.25mm beryllium window. ISO rating: C43333

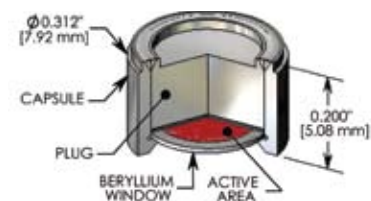

Nominal Activity		Part Numbers	Regulatory
mCi	MBq	3204	SS&DR / SFC
1	37	FE532040001M	Yes / Yes
5	185	FE532040005M	Yes / Yes
10	370	FE532040010M	Yes / Yes
30	1110	FE532040030M	Yes / Yes
40	1480	FE532040040M	Yes / Yes
50	1850	FE532040050M	Yes / Yes
100	3700	FE532040100M	Yes / Yes
			Availability: 4 weeks

3205 capsule

Single-encapsulated stainless steel source with 0.04"/1.0mm beryllium window. ISO rating: C43333

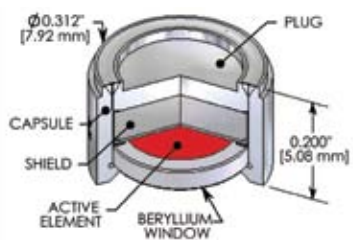

Nominal Activity		Part Numbers	Regulatory
mCi	MBq	3205	SS&DR / SFC
1	37	FE532050001M	Yes / No
5	185	FE532050005M	Yes / No
10	370	FE532050010M	Yes / No
30	1110	FE532050030M	Yes / No
40	1480	FE532050040M	Yes / No
50	1850	FE532050050M	Yes / No
100	3700	FE532050100M	Yes / No
			Availability: 4 weeks

3215 capsule

Single-encapsulated stainless steel source with 0.01"/0.25mm beryllium window. ISO rating: C33222

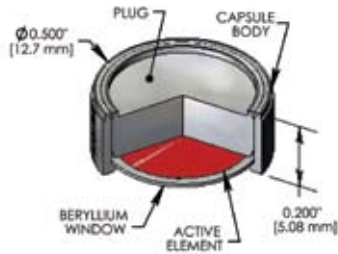

Nominal Activity		Part Numbers	Regulatory
mCi	MBq		
		3215	SS&DR / SFC
1	37	FE532150001M	Yes / No
5	185	FE532150005M	Yes / No
10	370	FE532150010M	Yes / No
30	1110	FE532150030M	Yes / No
40	1480	FE532150040M	Yes / No
50	1850	FE532150050M	Yes / No
100	3700	FE532150100M	Yes / No
			Availability: 4 weeks

3236 capsule

Single-encapsulated stainless steel source with 0.10"/0.25mm beryllium window. ISO rating: C54243

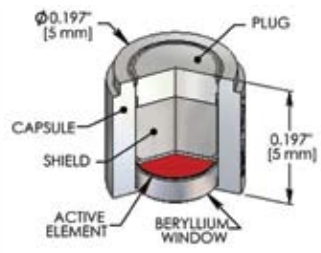

Nominal Activity		Part Numbers	Regulatory
mCi	MBq		
		3236	SS&DR / SFC
1	37	FE532360001M	Yes / No
5	185	FE532360005M	Yes / No
10	370	FE532360010M	Yes / No
30	1110	FE532360030M	Yes / No
40	1480	FE532360040M	Yes / No
50	1850	FE532360050M	Yes / No
100	3700	FE532360100M	Yes / No
			Availability: 4 weeks

Am-241
Am-241/Be
Ba-133
Cd-109
Cs-137
Cs-137
Eu-152
Fe-55
Gd-153
K-85
Mössbauer
Na-22
Ni-63
Pm-147
Ru-106
Se-75
Sr-90
Yb-169

Gd-153

Standard Capsule Designs

Activity Tolerance

± 15% from nominal

Recommended Working Life

See Technical Information section.

Only typical sources are listed; inquiries are invited for alternative capsule designs and activities.

For Low Energy Gamma applications, Gd-153 sources offer a radionuclide with gamma emissions around 100keV, and X-rays between 41keV and 49keV.

The activity is contained in a stable, homogeneous active element.

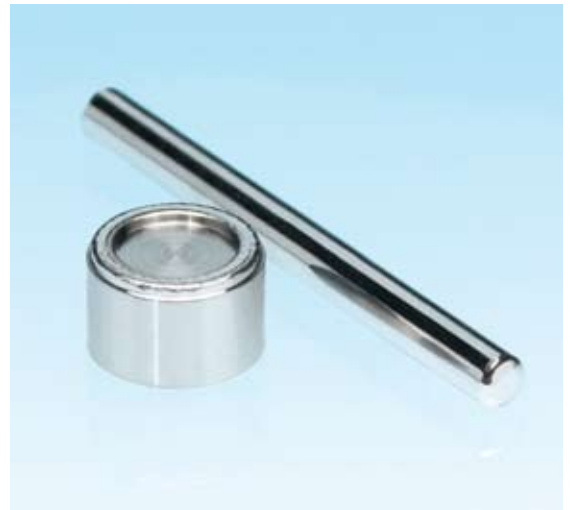

3201 capsule

Double-encapsulated stainless steel source. ISO rating: C66545

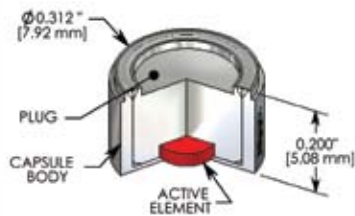

Nominal Activity		Part Numbers	Regulatory
mCi	MBq		
		3201	SS&DR / SFC
5	185	GD332010005M	Yes / Yes
10	370	GD332010010M	Yes / Yes
20	740	GD332010020M	Yes / Yes
50	1850	GD332010050M	Yes / Yes
100	3700	GD332010100M	Yes / Yes
			Availability: 4 weeks

3402 capsule

Double-encapsulated stainless steel line source. Also available in titanium. ISO rating: C33222X

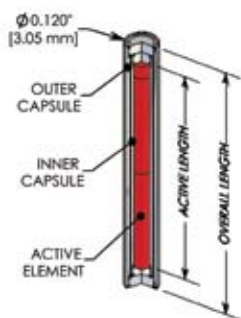

Nominal Activity		Part Numbers	Regulatory
mCi	MBq		
		3402	SS&DR / SFC
5	185	GD334020005M	Yes / Yes
10	370	GD334020010M	Yes / Yes
20	740	GD334020020M	Yes / Yes
50	1850	GD334020050M	Yes / Yes
100	3700	GD334020100M	Yes / Yes
			Availability: 4 weeks



Eckert & Ziegler Isotope Products' source production laboratory.

Am-241

Am-241/Be

Ba-133

Cd-109

Cf-252

Co-57

Co-60

Cs-137

Eu-152

Fe-55

Gd-153

Kr-85

Mossbauer

Na-22

Ni-63

Pm-147

Ru-106

Sc-75

Sr-90

Yb-169

Kr-85

Standard Capsule Designs

Activity Tolerance

± 15% from nominal

Recommended Working Life

See Technical Information section.

Only typical sources are listed; inquiries are invited for alternative capsule designs and activities.

For medium energy Beta gauging applications, these Kr-85 gas-filled sources offer a radionuclide with beta energies up to ~680keV.



NER584 / NER586 series

Single-encapsulated titanium source with 0.002" (0.051mm) titanium window. Activities up to 2200mCi (81.4GBq). Typical capsule configurations are shown below; please contact us for assistance before ordering.

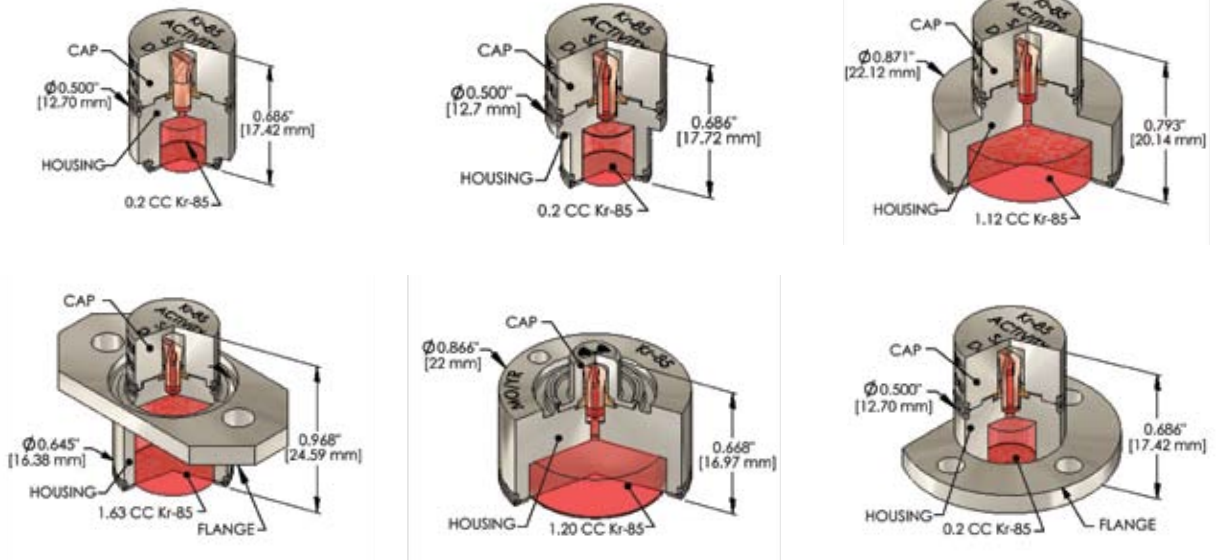

NER585 series

Single-encapsulated stainless steel source with 0.002" (0.05mm) stainless steel window. Activities up to 3000mCi (111GBq). Typical capsule configurations are shown below; please contact us for assistance before ordering.

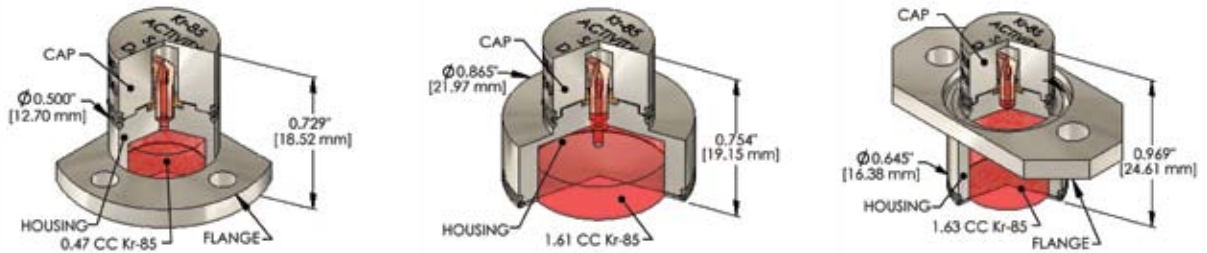

NER587 capsule

Single-encapsulated titanium source with titanium window. ISO rating: C33332

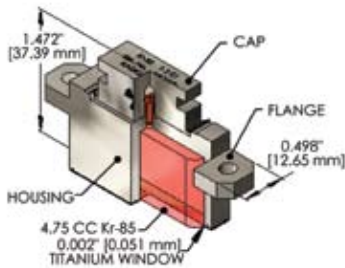

Nominal Activity		Part Numbers	Regulatory
mCi	MBq	NER587	SS&DR / SFC
10	370	KR5NER5870010M	Yes / No
50	1850	KR5NER5870050M	Yes / No
100	3700	KR5NER5870100M	Yes / No
200	7400	KR5NER5870200M	Yes / No
500	18500	KR5NER5870500M	Yes / No
1000	37000	KR5NER5870001C	Yes / No
2000	74000	KR5NER5870002C	Yes / No
			Availability: 8 weeks

NER588 capsule

Single-encapsulated titanium source with titanium window. ISO rating: C33332

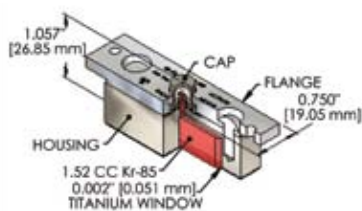

Nominal Activity		Part Numbers	Regulatory
mCi	MBq	NER587	SS&DR / SFC
100	3700	KR5NER58800100M	Yes / No
500	18500	KR5NER58800500M	Yes / No
1000	37000	KR5NER58801000M	Yes / No
2000	74000	KR5NER58802000M	Yes / No
2500	92500	KR5NER5882500M	Yes / No
			Availability: 8 weeks

Am-241
Am-241/Be
Ba-133
Cd-109
Cs-137
Eu-152
Fe-55
Gd-153
Kr-85
Mössbauer
Na-22
Ni-63
Pm-147
Ra-106
Sc-75
Sr-90
Yb-169

Kr-85

Standard Capsule Designs

NER8170 capsule

Single-encapsulated titanium source with titanium window. ISO rating: C333232

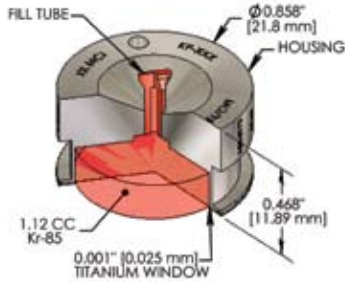

Nominal Activity		Part Numbers	Regulatory
mCi	MBq	NER8170	SS&DR / SFC
10	370	KR5NER81700010M	Yes / No
20	740	KR5NER81700020M	Yes / No
50	1850	KR5NER81700050M	Yes / No
100	3700	KR5NER81700100M	Yes / No
200	7400	KR5NER81700200M	Yes / No
500	18500	KR5NER81700500M	Yes / No
1150	42550	KR5NER81701150M	Yes / No
			Availability: 8 weeks

NER8180 capsule

Single-encapsulated titanium source with titanium window. ISO rating: C33322

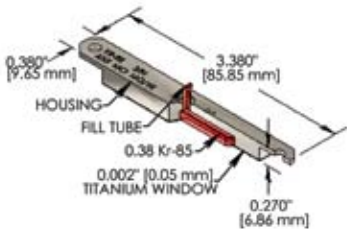

Nominal Activity		Part Numbers	Regulatory
mCi	MBq	NER8180	SS&DR / SFC
10	370	KR5NER81800010M	Yes / No
20	740	KR5NER81800020M	Yes / No
50	1850	KR5NER81800050M	Yes / No
100	3700	KR5NER81800100M	Yes / No
300	11100	KR5NER81800300M	Yes / No
700	25900	KR5NER81800700M	Yes / No
1500	55500	KR5NER81801500M	Yes / No
			Availability: 8 weeks



Am-241
Am-241/Be
Ba-133
Cd-109
Cf-252
Co-57
Co-60
Cs-137
Eu-152
Fe-55
Gd-153
Kr-85
Mossbauer
Na-22
Ni-63
Pm-147
Ru-106
Se-75
Sr-90
Yb-169

Mössbauer Sources

Mössbauer Effect Sources and Absorbers

Mössbauer Effect Sources

Applications of the Mössbauer Effect utilize recoilless nuclear absorption of low energy gamma rays, a phenomenon discovered by Rudolf Mössbauer in 1957. This phenomenon facilitates studies of the chemical and electromagnetic environment of the resonant nucleus.

Mössbauer Effect cobalt sources are prepared by the electrodeposition of Co-57 onto a variety of metal foils, commonly copper, palladium, or pure iron, followed by hydrogen annealing to diffuse the cobalt into the foil. This produces a special type of radioactive source emitting gamma rays (photons) of well-defined energy that produce the Mössbauer Effect. The effect depends upon the emission of low energy gamma rays from a nucleus without energy loss in nuclear recoil. The emitted photon then possesses the full translational energy and is capable of resonant absorption in a stable nucleus of the same nuclide. The effect is obtained by diffusing a suitable radionuclide into the matrix to eliminate nuclear recoil. An unsplit resonance absorption line results when a Co-57 source on a non-ferro-magnetic matrix (such as stainless steel or palladium) is used with a pure Fe-57 absorber deposited on a non-magnetic surface such as 300 series stainless steel. Hyperfine magnetic splitting of the spectrum results when the matrix or absorber is ferromagnetic (such as pure iron).

Mössbauer Effect Sources are prepared to order to ensure the best performance characteristics. Particular attention is given to optimizing the annealing and quenching conditions.

Active metal foils are supplied in a demountable plastic holder for attachment to a velocity transducer. The foil itself, which may be removed from the holder, is coated with a tough, radiation resistant polyimide film 9mg/cm² thick and meets NRC leak test requirements for Sealed Sources. The foil diameter for the standard mount is 0.5" (12.7mm) with an active diameter of 0.25" (6.35mm). Alternate mounts such as Ranger and Austin styles are available upon request.

Other nuclides may be available. Please contact Eckert & Ziegler Isotope Product's Customer Service for more information (see Inquiry Form at back of catalog).

Certified Cobalt-57 Sources

Each Co-57 source is supplied with two pure iron and two type 310 stainless steel absorbers. At least 35% effect is expected for each source in copper and platinum matrices.

Standard Activities

1mCi	37Mq
2mCi	74MBq
5mCi	185MBq
10mCi	370MBq
15mCi	555MBq
20mCi	740MBq
25mCi	925MBq
50mCi	1850MBq
100mCi	3700MBq

Part Numbers	Thickness *		Substrate	FWHM (mm/s)
MOS-057RH	0.000472"	0.012mm	Rhodium	0.27
MOS-057CU	0.000472"	0.012mm	Copper	0.27
MOS-057PD	0.000472"	0.012mm	Palladium	0.27
MOS-057PT	0.000984"	0.025mm	Platinum	0.27
MOS-057FE	0.000394"	0.01mm	Pure Iron	0.30
MOS-057NI	0.000512"	0.013mm	Nickel	0.30
MOS-057SS	0.000394"	0.01mm	Type 310 S/S	0.45

Availability: please inquire

* These thicknesses have been chosen as suitable for most applications. Thicker or thinner substrates of all these metals are usually available and may be substituted on request.

Velocity Calibration Absorbers

This absorber permits rapid resolution of the six lines in the magnetic hyperfine splitting in Fe-57m. The absorber is prepared by electrodeposition of highly enriched Fe-57 onto a thin foil of natural iron followed by diffusion bonding under hydrogen. A 500 µg/cm² acrylic coating prevents oxidation.

The thin absorber (approx. 6.5mg/cm²) allows a high transmission fraction of the 14keV gamma while yielding a high percentage effect (15% on the inner lines, 20% on the outer, uncorrected for background).

Natural iron and 310 stainless steel absorbers are also available. Two each of these absorbers are included with the purchase of any Mössbauer source.

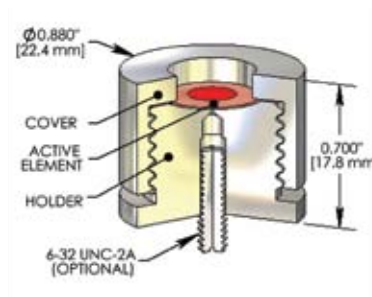

Mössbauer Effect Source with Standard Mount

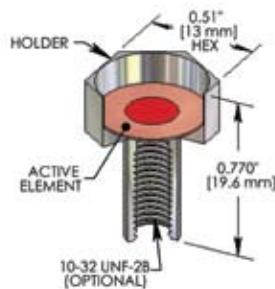

Mössbauer Ranger Mount

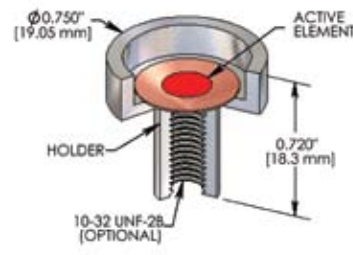

Mössbauer Austin Mount

Part Numbers	Material	Substrate	Thickness
MOS-NA-10	Pure iron (natural)	1" x 1" (25.4mm x 25.4mm)	4.72mg/cm ² 19.7mg/cm ²
MOS-NA-11	Type 310 stainless steel	1" x 1" (25.4mm x 25.4mm)	39.4mg/cm ²

Availability: supplied with order; otherwise 4-6 weeks

Am-241
Am-241/Be
Ba-133
Cd-109
Cf-252
Co-57
Co-60
Cs-137
Eu-152
Fe-55
Gd-153
Kr-85
Mössbauer
Na-22
Ni-63
Pm-147
Ru-106
Se-75
Sr-90
Yb-169

Na-22

Standard Capsule Designs

Activity Tolerance

± 15% from nominal

Recommended Working Life

See Technical Information section.

Only typical sources are listed; inquiries are invited for alternative capsule designs and activities.

For High Energy Gamma or positron applications these Na-22 sources offer a high energy gamma line at 1275keV, along with β^+ annihilation emissions at 511keV. The activity is in a stable, homogeneous active element.



3000 capsule

Double-encapsulated stainless steel source. ISO rating: C66545

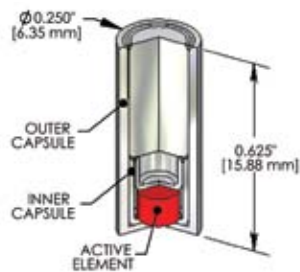

Nominal Activity		Part Numbers	Regulatory
mCi	MBq	3000	SS&DR / SFC
0.001	0.037	NA230000001U	Yes / Yes
0.01	0.37	NA230000010U	Yes / Yes
0.1	3.7	NA230000100U	Yes / Yes
0.5	18.5	NA230000500U	Yes / Yes
1	37	NA230000001M	Yes / Yes
10	370	NA230000010M	Yes / Yes
			Availability: 4 weeks

3025 capsule

Single-encapsulated stainless steel source. ISO rating: C66434

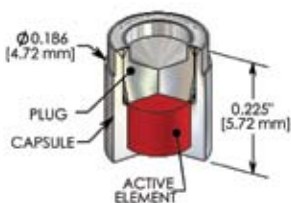

Nominal Activity		Part Numbers	Regulatory
mCi	MBq	3025	SS&DR / SFC
0.001	0.037	NA230250001U	Yes / Yes
0.01	0.37	NA230250010U	Yes / Yes
0.1	3.7	NA230250100U	Yes / Yes
0.5	18.5	NA230250500U	Yes / Yes
1	37	NA230250001M	Yes / Yes
10	370	NA230250010M	Yes / Yes
			Availability: 4 weeks

Ni-63

Standard Capsule Designs

Activity Tolerance

± 15% from nominal

Recommended Working Life

See Technical Information section.

Only typical sources are listed; inquiries are invited for alternative capsule designs and activities.

For low energy beta applications (such as Electron Capture Detection/ Ion Mobility Spectroscopy) these Ni-63 Sources offer beta emissions up to 66keV.



Nickel Foil Sources

Nickel foil with Ni-63 electrodeposited onto one surface. Optional inactive Nickel overplate available. A serial number is etched onto the outer inactive surface. ISO rating: C42211.

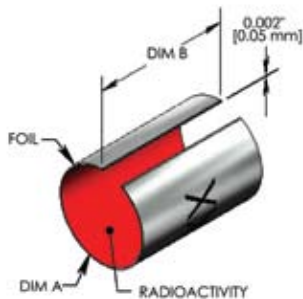

Nominal Activity		Part Numbers	Regulatory
mCi	MBq	4500	SS&DR / SFC
0.1	3.7	NI345000100U	Yes / No
0.5	18.5	NI345000500U	Yes / No
1	37	NI345000001M	Yes / No
2	74	NI345000002M	Yes / No
5	185	NI345000005M	Yes / No
10	370	NI345000010M	Yes / No
15	555	NI345000015M	Yes / No

Availability: 4-6 weeks

Foils can be ordered with a wide range of dimensions. Please inquire for details.

NER-004R Nickel Ring Sources

Nickel or brass ring with Ni-63 electrodeposited onto all surfaces. Optional inactive Nickel overplate available. ISO Rating: C42211

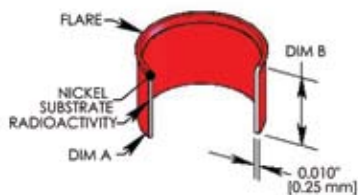

Nominal Activity		Part Numbers	Regulatory
mCi	MBq	NER-004R	SS&DR / SFC
0.1	3.7	NER-004R-100U	Yes / No
0.5	18.5	NER-004R-500U	Yes / No
1	37	NER-004R-1M	Yes / No
2	74	NER-004R-2M	Yes / No
5	185	NER-004R-5M	Yes / No
10	370	NER-004R-10M	Yes / No
15	555	NER-004R-15M	Yes / No

Availability: 4-6 weeks

Rings can be ordered with various dimensions. Please inquire for details.

Am-241
Am-241/Be
Ba-133
Cd-109
Cf-252
Co-57
Co-60
Cs-137
Eu-152
Fe-55
Gd-153
Kr-85
Mossbauer
Nd-147
Ni-63
Pm-147
Rn-222
Sr-90
Yb-169

Pm-147

Standard Capsule Designs

Activity Tolerance

± 15% from nominal

Recommended Working Life

See Technical Information section.

Only typical sources are listed; inquiries are invited for alternative capsule designs and activities.

For medium energy Beta gauging applications, these Pm-147 sources offer a radionuclide with beta energies up to ~225keV. The activity is contained within a stable, homogeneous active element.



3882 capsule

Single-encapsulated source with thin end window. Available in stainless steel, platinum/iridium, titanium or nickel. ISO rating: C22232. Maximum length of Dimension A is 0.180"/4.57mm.

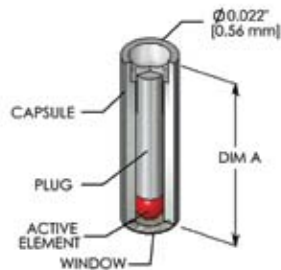

Nominal Activity		Part Numbers	Regulatory
mCi	MBq		
		3882	SS&DR / SFC
0.9	33.3	PM738820900U	Yes / No
1.2	44.4	PM738821200U	Yes / No
3.0	111	PM738820003M	Yes / No
5.0	185	PM738820005M	Yes / No
9.0	333	PM738820009M	Yes / No
24.0	888	PM738820024M	Yes / No

Availability: 4-6 weeks

Ru-106

Standard Capsule Designs

Activity Tolerance

± 15% from nominal

Recommended Working Life

See Technical Information section.

Only typical sources are listed; inquiries are invited for alternative capsule designs and activities.

For high energy Beta applications, these Ru-106 Sources offer a radionuclide with beta energies up to ~2.5MeV, and gamma emissions up to 1562keV. The activity is in a stable, homogeneous active element.

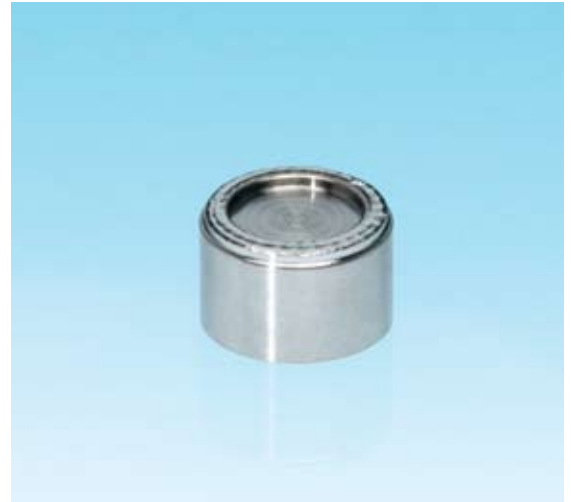

3222 capsule

Single-encapsulated stainless steel source with thin end window. ISO rating C33222

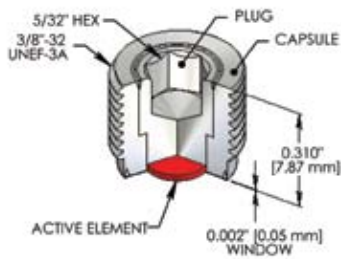

Nominal Activity		Part Numbers	Regulatory
mCi	MBq		
		3222	SS&DR / SFC
0.1	3.7	RU632220100U	No / Yes
0.2	7.4	RU632220200U	No / Yes
0.5	18.5	RU632220500U	No / Yes
1	37	RU632220001M	No / Yes
2	74	RU632220002M	No / Yes
			Availability: 4-6 weeks

Am-241
Am-241/Be
Ba-133
Cd-109
Cf-252
Co-57
Co-60
Cs-137
Eu-152
Fe-55
Gd-153
Kr-85
Mössbauer
Na-22
Ni-63
Pm-147
Ru-106
Se-75
Sr-90
Yb-169

Se-75

Standard Capsule Designs

Activity Tolerance

± 15% from nominal

Recommended Working Life

See Technical Information section.

Only typical sources are listed; inquiries are invited for alternative capsule designs and activities.

For medium energy gamma applications, these Se-75 sources offer gamma energies between 66keV and ~400keV. The activity is in a stable, homogeneous active element.



3616 capsule

Double-encapsulated aluminum or titanium capsule. ISO rating: C43513

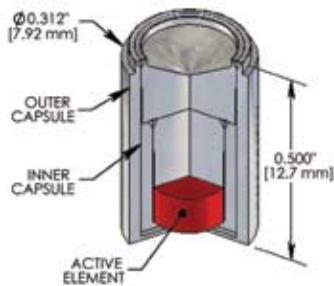

Nominal Activity		Part Numbers	Regulatory
mCi	MBq		
		3616	SS&DR / SFC
20	740	SE536160020M	Yes / No
50	1850	SE536160050M	Yes / No
100	3700	SE536160100M	Yes / No
200	7400	SE536160200M	Yes / No
400	14800	SE536160400M	Yes / No
			Availability: 6 weeks

Sr-90

Standard Capsule Designs

Activity Tolerance

± 15% from nominal

Recommended Working Life

See Technical Information section.

Only typical sources are listed; inquiries are invited for alternative capsule designs and activities.

For high energy Beta applications, these Sr-90 Sources offer a long-lived radionuclide with beta energies up to ~2.3MeV. The activity is in a stable, homogeneous active element.

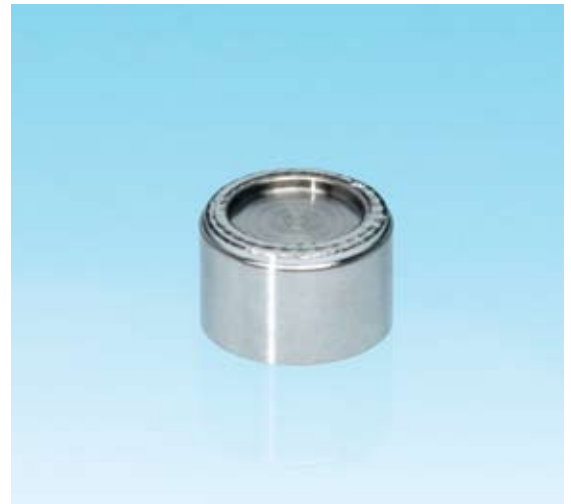

3203 capsule

Single-encapsulated stainless steel capsule with 0.002" (0.051mm) end window. ISO rating: 66545

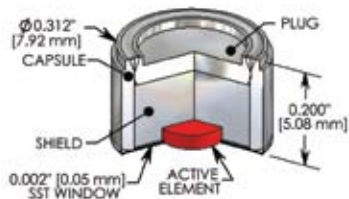

Nominal Activity		Part Numbers	Regulatory
mCi	MBq		
		3203	SS&DR / SFC
1	37	SR032030001M	Yes / No
2	74	SR032030002M	Yes / No
5	185	SR032030005M	Yes / No
10	370	SR032030010M	Yes / No
20	740	SR032030020M	Yes / No
50	1850	SR032030050M	Yes / No
			Availability: see note

Sr-90 sources are made in batches at intervals several times per year. If the requested activity is available from stock, sources are normally delivered within two weeks. Please inquire for current availability.

Am-241
Am-241/Be
Ba-133
Cd-109
Cf-252
Co-57
Co-60
Cs-137
Eu-152
Fe-55
Gd-153
Kr-85
Mossbauer
Na-22
Ni-63
Pm-147
Ru-106
Se-75
Sr-90
Yb-169

Yb-169

Standard Capsule Designs

Activity Tolerance

± 15% from nominal

Recommended Working Life

See Technical Information section.

Only typical sources are listed; inquiries are invited for alternative capsule designs and activities.

Yb-169 has significant X-ray emissions between 49keV and 59keV, in addition to gamma emissions from 63keV up to 308keV. The activity is in a stable, homogeneous active element.



3603 capsule

Double-encapsulated aluminum source. ISO rating: C43333

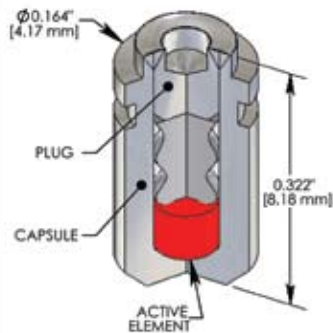

Nominal Activity		Part Numbers	Regulatory
mCi	MBq	3603	SS&DR / SFC
100	3700	YB936030100M	Yes / No
300	11100	YB936030300M	Yes / No
600	22200	YB936030600M	Yes / No
1000	37000	YB936030001C	Yes / No
			Availability: 8-10 weeks



Custom Services

Special Designs & Testing

Special Source Design

Throughout this catalog, standard capsule designs are shown along with standard activities for each radionuclide. Other source designs may be possible. If your particular application requires a design not shown here, please complete the Inquiry Form at the back of the catalog and submit the form along with any relevant supporting documentation (drawings, etc.) to the fax number or email address shown. Eckert & Ziegler Isotope Products will contact you to discuss your requirements and where feasible prepare a quotation for an appropriate source design.

Capsule Testing

Where required, Eckert & Ziegler Isotope Products can undertake capsule testing for applications and special shipping requirements. Please use the Inquiry Form to submit your request.

Source Calibration

Eckert & Ziegler Isotope Products can provide calibrations for certain sources. If your application requires a calibrated source, please submit your request using the Inquiry Form.

Containers

Please contact Eckert & Ziegler Isotope Products if you wish to purchase a shipping container. Please submit your request using the Inquiry Form.

Source Handling

If you require advice or special equipment to handle radiation sources, please contact Eckert & Ziegler Isotope Products using the Inquiry Form.

Instrument Calibration & Medical Imaging

Eckert & Ziegler Isotope Products offers a comprehensive range of calibration sources (with NIST+DKD traceability) and services, as well as sources for medical imaging applications. If your radiation source requirement is in either of these categories, please contact Eckert & Ziegler Isotope Products' Sales Department to discuss your needs and to request an appropriate product catalog.

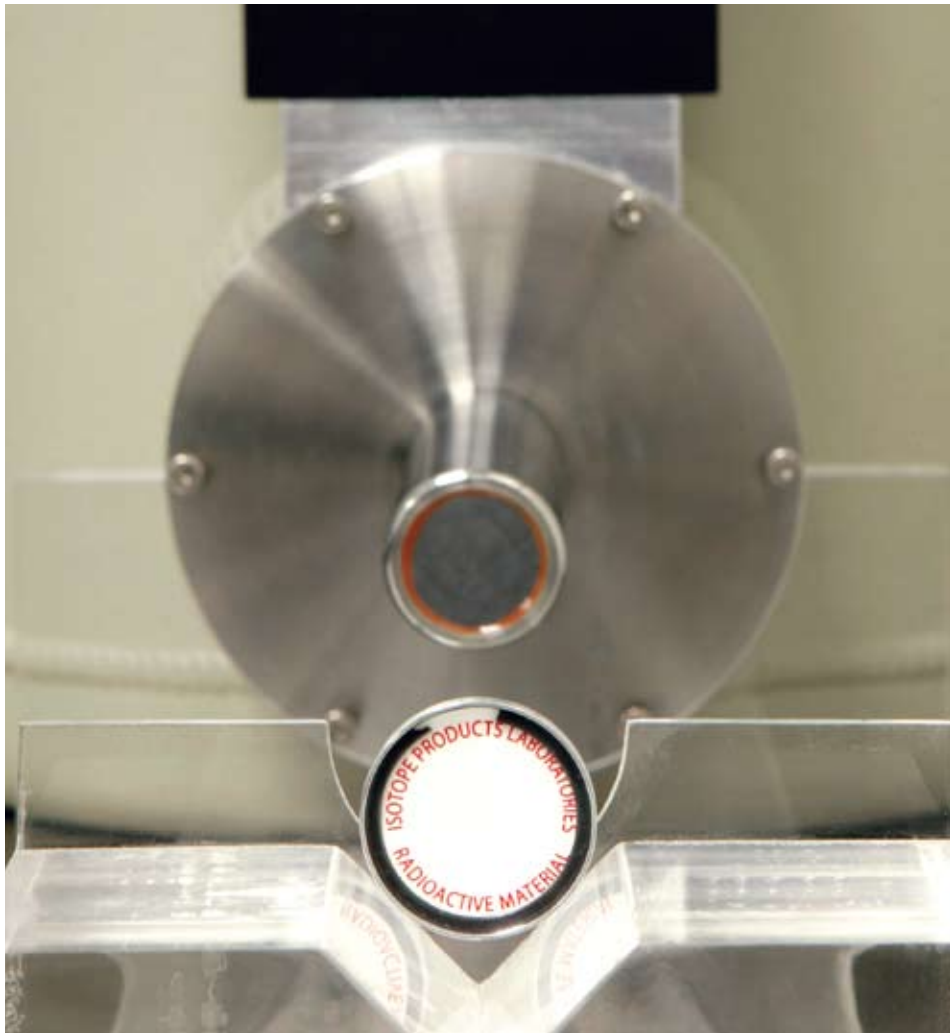

Eckert & Ziegler Isotope Products: Si/Li detector, used for source calibration in the Radioassay department.

QA Information

System & Regulations

Quality Management System (ISO9001:2000)

Eckert & Ziegler Isotope Products (formerly known as IPL: Isotope Products Laboratories) established in 1967 is a manufacturing company specializing in the production of various types of radiation sources. Its products cover the development, manufacturing, testing, calibration, and sale of radioactive sources for medical, industrial, analytical, and environmental applications.

The Quality Management System used at Eckert & Ziegler Isotope Products enables management and employees to comply with its Quality Policy and to realize its objectives.

The Quality Management System provides for an organized systematic approach to activities affecting quality, including verification. It assures that each activity has been satisfactorily performed, and demonstrates that the desired level of quality has been achieved in order to achieve customer satisfaction.

The Quality Management System governs activities conducted at the following Eckert & Ziegler Isotope Products locations:

1800 North Keystone St., Burbank, California 91504

1811 Keystone St., Burbank, California 91504

2319 Empire St., Burbank, California 91504

24937 Avenue Tibbitts, Valencia, California 91355

Eckert & Ziegler Isotope Products' goal is to assure that products are manufactured, tested, and calibrated to contractual requirements including performance, function, and delivery, and to realize Quality Management System objectives.

Eckert & Ziegler Isotope Products complies with the following Regulations and Standards.

- ISO 9001:2000, Quality Management Systems Requirements
- ISO 9001:1994, Quality Systems - Model for Quality Assurance in Design, Development, Production, Installation and Servicing
- ISO 13485:1996, Quality Systems - Medical Devices - Particular Requirements for the Application of ISO 9001
- ISO 13485:2003, Medical Devices – Quality Management Systems – Requirements for Regulatory Purposes
- CMDR: Canadian Medical Device Regulations, sections 1 to 78
- ISO 14971:2000, Medical Devices – Application of Risk Management to Medical Devices
- Food and Drug Administration (FDA), 21 CFR 820, Quality System Regulation
- 93/42/EEC, Medical Device Directive
- ISO/TR 10013:2001 Guidelines for quality management system documentation
- ISO 9000:2000(E), Quality Management Systems – Fundamentals and Vocabulary
- 10 CFR 50, Appendix B, Quality Assurance Criteria for Nuclear Power Plants and Fuel Reprocessing Plants
- ISO/IEC 17025:2005, General Requirements for the Competence of Testing and Calibration Laboratories
- ISO 2919:1999, Radiation Protection – Sealed Radioactive Sources – General Requirements and Classification
- ISO 9978:1992, Radiation Protection – Sealed Radiation Sources – Leakage Test Methods
- Nuclear Regulatory Commission, 10 CFR Parts 1-50
- Title 17, State of California Code of Regulations, Division 1, Chapter 5, Subchapter 4 (Radiation)
- NIST / NEI, National Institute of Standards and Technology / Nuclear Energy Institute
- Department of Transportation (DOT), 49 CFR Parts 100-185
- IAEA, International Atomic Energy Agency; Regulations for the Safe Transport of Radioactive Material (IAEA TS-R-1)
- IATA Dangerous Goods Regulations; International Air Transport Association
- ICAO, International Civil Aviation Organisation
- ISO 14971:2007

General Information

Purchasing & Licensing

Ordering Procedures

Call +1 (661) 309-1010

Fax +1 (661) 257-8305

Email sales@ezag.com

Web www.isotopeproducts.com

We encourage telephone orders which enable matters of availability, technical specifications, and mode of shipment to be resolved promptly. All orders should be confirmed either by Fax or mail. Orders for custom sources must be confirmed in writing before work can be started. The following information must be included with your order:

1. Model number, radionuclide, activity, and capsule configuration
2. Purchase Order number
3. Shipping and Billing addresses
4. Method of shipment

Mail all Orders and Confirmations, to:

Eckert & Ziegler Isotope Products

24937 Avenue Tibbits

Valencia, CA 91355

USA

Customers in the European region may contact our sales office in Berlin, Germany:

Eckert & Ziegler Isotope Products GmbH

Robert-Rössle-Str. 10

13125 Berlin, Germany

Tel: +49 30 94 10 84 300

Fax: +49 30 91 10 84 180

Any customer-supplied components must receive an Authorization Number from Eckert & Ziegler Isotope Products prior to shipping.

Licensing Requirements

It is company policy to require written verification of the customer's Agreement State or NRC Radioactive Materials License for all items. No orders will be processed without a copy of your license on file at Eckert & Ziegler Isotope Products. Compliance with applicable local, state, and federal regulations concerning procurement and possession of radioactive materials is the responsibility of the customer. A listing of the Nuclear Regulatory Commission (NRC) and each state's radiation offices is available upon request.

Exempt Quantities

Small amounts of some byproduct material may be purchased without a specific license per NRC regulations 10 CFR 30.18 and 10 CFR 30.71 Schedule B or the equivalent state regulations. Sources purchased as Exempt Quantities must be catalog items. Many sources listed in the pages of this catalog are available as Exempt sources. Custom sources must be specifically licensed. Up to ten license exempt radioactive standards or sources may be shipped at one time. NRC regulations prohibit the further incorporation or use of license exempt sources in a manufactured device intended for further distribution. Contact the NRC or your state agency for information on the use or possession of license exempt sources.

Quality Assurance

Eckert & Ziegler Isotope Products maintains a comprehensive Quality Assurance program based upon several standards and regulations set forth in 10 CFR 50 Appendix B, and NRC Regulatory Guide 6.9.

Pricing

All prices listed in the price list are EXW, Burbank, California: (Ex-Works: Refer to INCOTERMS 2000 for further information). Any variance to this must be agreed at the time of ordering. All transportation, handling, and insurance costs are charged to the customer. We reserve the right to change prices without notice although every attempt will be made to give reasonable notice of price adjustments, and supplementary price schedules will be issued whenever appropriate.

Product Changes

New product and method development is a continuing process at Eckert & Ziegler Isotope Products. Catalog specifications notwithstanding, we reserve the right to change production methods or fabrication techniques which do not diminish the performance of the product.

Return Shipments and Credits

Due to the nature of the products, all sales are final and no items can be returned for credit unless the customer has demonstrated that the product did not meet agreed specifications. Such a claim must be made within thirty (30) days after receipt of shipment. Before any return is made, Eckert & Ziegler Isotope Products must be notified so that a return authorization (RMA) number can be assigned and proper shipping arrangements can be made.

Availability

Since Eckert & Ziegler Isotope Products manufactures a large variety of products with many options, only a small inventory of certain finished products can be maintained. Many items can be shipped in 4 – 6 weeks after receipt of order. Please contact the Sales Order Department for more information regarding the availability of a certain product or radionuclide.

Packaging and Shipping

The majority of radioactive standards are packaged in DOT 7A Type A non-returnable containers and are shipped air freight. Certain quantities of alpha emitters and high level gamma sources require the use of a Type B returnable container. Rental fees for the Type B container will be supplied with the source quotation when applicable.

Most high energy gamma sources require the use of a shielded shipping container. The majority of these containers are non-returnable and become the property of the customer. Prices for both returnable and non-returnable containers will be supplied with the source quotation.

Terms, Conditions and Warranty

Eckert & Ziegler Isotope Products' payment terms are net 30 days from date of shipment, delays in mailing of invoice notwithstanding.

Unless otherwise agreed, all payments are to be made in U.S. Dollars. A \$300 documentary handling charge will be assessed to all orders involving a documentary letter of credit or draft for collection. A \$50 handling fee will be charged for all orders involving prepayment via wire transfer of funds. All new accounts must submit banking information and three references for credit review. Please allow three days to verify your credit status.

Packaging Information

Shipping Containers & Special Form

Packaging and Shipping Containers

Packaging and shipment of radioactive materials at Eckert & Ziegler Isotope Products adhere to the regulations of the U.S. Department of Transportation (DOT) regulations 49 CFR, the International Civil Aviation Organization (ICAO) and of the International Air Transportation Association (IATA).

IPL uses four types of packaging to ship radioactive materials:

- Excepted Packaging
- Type A
- Type B(U)
- Type B(M)

Excepted Packaging (Limited Quantity) is used when the activity limits do not exceed those defined in 49 CFR 173.425 and IATA regulations table 10.5.A (2007) and the radiation level at any point on the package does not exceed 0.5 millirem per hour. All boxes shipped from Eckert & Ziegler Isotope Products as "Excepted Packages" meet the requirements of 49 CFR 173.421 and IATA regulation 10.5.9.

Type A Packaging is used to carry normal form radioactive material as defined by the A_2 values of 49 CFR 173.435 and IATA 10.4.A (2007) and Special Form* encapsulated radioactive material.

In the standard Type A configuration, sources are sealed in an inner container and centered in a fiberboard box. Sources requiring heavy shielding are shipped in a lead shield centered in a fiberboard box.

Type B Packaging is used to carry quantities of radioactive material in excess of the A_2 values of 49 CFR 173.435 and IATA 10.4.A (2007) that are not contained in a capsule that has been issued a Special Form Radioactive Material certificate by a National Competent Authority such as the U.S. Department of Transportation.

The standard Type B container used by Eckert & Ziegler Isotope Products is a 30 or 55 gallon steel drum with a 5" (12.7cm) diameter 2R inner container. The container has been issued Competent Authority certification for a Type B Fissile Radioactive Materials Package by the U.S. Department of Transportation.

Radiation levels on the external surfaces of all packages and at a distance of one meter from all external surfaces (Transport Index) will not exceed the limits set in 49 CFR 173.441 or IATA 10.5.17 (2007). All measurements are made with an Eberline RO2 (or equivalent) radiation survey instrument.

Unless special arrangements are made with the customer in advance, radiation levels at the surface of any shielded container will not exceed 200millirem per hour as measured with an Eberline RO2 (or equivalent) radiation survey instrument.

*Special Form Radioactive Material

Sealed radiation sources which have passed the requisite performance tests described in the regulations for the Safe Transport of Radioactive Material, 1996 Edition (Revised), International Atomic Energy Agency (IAEA), No. TS-R-1 (ST-1, Revised) may be approved as Special Form Material by a National Competent Authority, for example by the U.S. Department of Transportation. Designation of Special Form allows for an increase in the activity limits for a Type A package.

A Note on Special Form

The safety concept applied to the shipping of packages containing radioactive materials assumes that both the capsule and the shipping container each form part of the protection that will prevent release of radioactive material into the environment during both normal transport conditions and accident conditions. For many cases it is more efficient to incorporate a high strength design into the source capsule itself than into the outer packaging. The testing program for such high strength source capsules is described in the IAEA Safety Series 6, and for the USA, in 49 CFR 173.469. Capsules which pass this testing regimen are called Special Form capsules (SFC). Special Form certification has no bearing on suitability for any particular use; it only applies to the shipping of the radioactive source.

Eckert & Ziegler Isotope Products has approved Special Form capsules only for those products that specifically require this testing and certification. Should a requirement for Special Form certification arise, please contact Eckert & Ziegler Isotope Products for a quotation to arrange testing and submission to the DOT.

Certification is undertaken in each country by a "Competent Authority". In the USA the Competent Authority is:

U.S. Department of Transportation
Research and Special Programs Administration
400 Seventh Street, S.W.
Washington, DC 20590
Tel: +1 (202) 366-4545

Technical Information

Capsule Data

Additional information for individual capsules can be found in the table below and on the following pages.

Capsule	Radionuclide	Model #	Max Act	SS&DR	ISO	RWL	SFC
2408	Co-57 Moss.	MOS-57	100mCi	Y	C11121	2y	N
2408	Co-57 Moss.	NER072	100mCi	Y	C11121	2y	N
3000	Ba-133	HEG-XXX	100mCi	Y	C66535	15y	Y
3000	Co-57	HEG-XXX	300mCi	Y	C66535	15y	Y
3000	Co-60	HEG-XXX	600mCi	Y	C66535	15y	Y
3000	Cs-137	HEG-XXX	600mCi	Y	C66535	15y	Y
3000	Eu-152	HEG-XXX	20mCi	Y	C66535	15y	Y
3011	Ba-133	193	100mCi	Y	C66545	15y	Y
3011	Co-60	193	300mCi	Y	C66545	15y	Y
3011	Cs-137	193	300mCi	Y	C66545	15y	Y
3011	Eu-152	193	20mCi	Y	C66545	15y	Y
3011	Na-22	193	100mCi	Y	C66545	15y	Y
3014	Cf-252	N-252	5mCi	Y	C66535	15y	Y
3015	Am-241	HEG-XXX	50mCi	Y	C66535	15y	Y
3015	Ba-133	HEG-XXX	100mCi	Y	C66535	15y	Y
3015	Co-60	HEG-XXX	600mCi	Y	C66535	15y	Y
3015	Cs-137	HEG-XXX	600mCi	Y	C66535	15y	Y
3015	Eu-152	HEG-XXX	20mCi	Y	C66535	15y	Y
3023	Cf-252	HEG-XXX	1mCi	Y	C63333	15y	Y
3024	Ba-133	HEG-XXX	100mCi	Y	C66535	15y	Y
3024	Cf-252	HEG-XXX	1mCi	Y	C66535	15y	Y
3024	Co-57	HEG-XXX	300mCi	Y	C66535	15y	Y
3024	Cs-137	HEG-XXX	600mCi	Y	C66535	15y	Y
3024	Eu-152	HEG-XXX	20mCi	Y	C66535	15y	Y
3025	Co-57	HEG-1	300mCi	Y	C66434	15y	Y
3025	Co-60	HEG-1	300mCi	Y	C66434	15y	Y
3025	Cs-137	HEG-1	300mCi	Y	C66434	15y	Y
3026	Cf-252	HEG-XXX	1mCi	Y	C66535	15y	Y
3026	Co-60	HEG-XXX	600mCi	Y	C66535	15y	Y
3027	Am-241/Be	3027	40mCi	Y	C66545	15y	Y
3036	Cf-252	n/a	1mCi	N	C66545	15y	N
3044	Co-60	n/a	5Ci	Y	C66646	15y	Y

Capsule Data

Capsule	Radionuclide	Model #	Max Act	SS&DR	ISO	RWL	SFC
3201	Am-241	PHI-XXXGFS	30mCi or 300mCi	Y	C66545	15y	Y
3201	Co-57	PHI-XXXGFS	300mCi	Y	C66545	15y	Y
3201	Cs-137	PHI-XXXGFS	300mCi	Y	C66545	15y	Y
3201	Eu-152	PHI-XXXGFS	300mCi	Y	C66545	15y	Y
3202	Co-57	PHI-XXXGFS	300mCi	Y	C66545	15y	Y
3203	Sm-151	PHI-XXXGFS	300mCi	Y	C66545	15y	Y
3203	Sr-90	PHI-XXXGFS	125mCi	Y	C66545	15y	Y
3204	Am-241	XFB-3	300mCi	Y	C43333	10y	Y
3204	Cd-109	XFB-3	300mCi	Y	C43333	2y	Y
3204	Co-57	XFB-3	300mCi	Y	C43333	2y	Y
3204	Fe-55	XFB-3	300mCi	Y	C43333	20y	Y
3205	Cd-109	XFB-3	300mCi	Y	C43333	2y	Y
3205	Co-57	XFB-3	300mCi	Y	C43333	2y	Y
3215	Am-241	HEG-XXX	300mCi	Y	C66535	10y	N
3215	Cd-109	XFB-5	300mCi	Y	C33222	2y	N
3215	Co-57	XFB-5	300mCi	Y	C33222	2y	N
3215	Fe-55	XFB-5	300mCi	Y	C33222	5y	N
3222	Ru-106	343	50mCi	N	C61411	2y	Y
3224	Ba-133	PHI-0094	10mCi	Y	C66444	15y	Y
3224	Co-57	PHI-XXXGFS	300mCi	Y	C66444	15y	Y
3224	Co-60	PHI-XXXGFS	300mCi	Y	C66444	15y	Y
3224	Cs-137	PHI-XXXGFS	300mCi	Y	C66444	15y	Y
3233	Am-241	XFB-3	300mCi	Y	C64344	10y	Y
3236	Cd-109	XFB-6	300mCi	Y	C54243	2y	N
3236	Fe-55	XFB-6	300mCi	Y	C54243	5y	N
3402	Ba-133	301 Series	300mCi	Y	C33222X	15y	Y
3402	Co-57	301 Series	300mCi	Y	C33222X	15y	Y
3402	Co-60	301 Series	300mCi	Y	C33222X	15y	Y
3402	Cs-137	301 Series	300mCi	Y	C33222X	15y	Y
3402	Eu-152	301 Series	300mCi	Y	C33222X	15y	Y
3603	Yb-169	R-169	5000mCi	Y	C43333	6m	N
3616	Se-75	R-75	5000mCi	Y	C43513	12m	N
3807	Co-57	PHI-XXXGFS	300mCi	Y	C66444	15y	N
3882	Pm-147	TCB-1	1300mCi	Y	C22232	15y	N
3888	Am-241	3888	500uCi	Y	C22212	15y	N

Technical Information

Capsule Data

Capsule	Radionuclide	Model #	Max Act	SS&DR	ISO	RWL	SFC
3888	Cs-137	3888	2mCi	Y	C22212	10y	N
3916	Am-241	3916	500uCi	Y	C22212	15y	N
4500	Ni-63	NER-004	50mCi	Y	C42211	15y	N
G10	Am-241	Am1.G10	300mCi	Y	C64545	15y	Y
G11	Am-241	Am1.G11	5Ci	Y	C64444	15y	Y
G22	Am-241	Am1.G22	5Ci	Y	C64444	15y	Y
G33	Am-241	Am1.G33	5Ci	Y	C64444	15y	Y
G44	Am-241	Am1.G44	5Ci	Y	C64444	15y	Y
G55	Am-241	Am.G55	5Ci	Y	C64444	15y	Y
G66	Am-241	Am1.66	5Ci	Y	C64444	15y	Y
N02	Am-241/Be	Am1.N02	100mCi	Y	C66545	15y	Y
N03	Am-241/Be	Am1.N03	23Ci	Y	E66646	15y	Y
N09	Am-241/Be	Am1.N09	1000mCi	Y	C66544	15y	Y
N09-1	Am-241/Be	Am1.N09-1	1000mCi	Y	C66544	15y	
N20	Am-241/Be	Am1.N20	3Ci	N	C66646	15y	N
NER584	Kr-85	NER584 Series	2.2Ci	Y	C33222	15y	N
NER585	Kr-85	NER585 Series	3Ci	Y	C33222	15y	N
NER587	Kr-85	NER587	2Ci	Y	C33222	15y	N
NER8170	Kr-85	NER-8170	1150mCi	Y	C33222	15y	N
NER8180	Kr-85	NER-8180	1500mCi	Y	C33222	15y	N
P02	Cs-137	Cs7.P02	500mCi	Y	C66646	15y	Y
P03	Co-60	n/a	1000mCi	N	C65445	15y	N
P03	Cs-137	Cs7.P03	1000mCi	Y	C65445	15y	Y
P04	Co-60	P04 Series	5Ci	Y	C66646	10y	Y
P04	Cs-137	P04 Series	10Ci	Y	C66646	15y	Y
P04-A	Cs-137	P04 Series	10Ci	Y	C66646	15y	Y

Capsule Data

Capsule	Radionuclide	Model #	Max Act	SS&DR	ISO	RWL	SFC
P05	Cs-137	Cs7.P05-1,3	3Ci	Y	C66646	15y	Y
P05	Co-60	Co0.P05-2	1.5Ci	Y	C66646	15y	Y
P08	Am-241/Be	Am1.P08	300mCi	Y	C64444	15y	N
P081	Am-241/Be	Am1.P081	300mCi	Y	C64444	15y	N
P13	Cs-137	XxY.P13	10Ci	Y	C66646	15y	Y
P13	Co-60	P13 Series	5Ci	Y	C66646	10y	Y
P17	Co-60	XxY.P13	5Ci	Y	C66646	15y	Y
P17	Cs-137	XxY.P17	10Ci	Y	C66646	15y	Y
P17-1	Co-60	XxY.P13	5Ci	Y	C66646	15y	Y
P17-1	Cs-137	XxY.P17	10Ci	Y	C66646	15y	Y
P20	Cs-137	n/a	10Ci	N	C66646	15y	Y

Key:

Model #	NRC Model number
MaxAct	Maximum Activity as defined by the SS&DR
SS&DR	Source registered in the Sealed Source and Device Registry
ISO	ANSI/ISO classification
RWL	Recommended Working Life of the radiation source
SFC	Special Form Certificate for a particular capsule design/configuration

3224 Capsule Dimensions: the following alternative capsule sizes are available:

Part Number	Dim A	Dim B
3224-01	0.118" (3.0 mm)	0.394" (10.0 mm)
3224-02	0.157" (4.0 mm)	0.394" (10.0 mm)
3224-03	0.275" (7.0 mm)	0.394" (10.0 mm)
3224-04	0.118" (3.0 mm)	0.394" (10.0 mm)

Technical Information

ANSI / ISO Classifications / Ratings / Typical Applications

ANSI / ISO Classification Table

TEST	CLASS						
	1	2	3	4	5	6	X
Temperature	No Test	-40°C (20min) +80°C (1h)	-40°C (20min)	-40°C (20min) +400°C (1h) and thermal shock to 20°C	-40°C (20min) +600°C (1h) and thermal shock to 20°C	-40°C (20min) +800°C (1h) and thermal shock to 20°C	Special Test
External Pressure	No Test	25kN/m ² abs. (3.6lbf/in ²) to atmosphere	25kN/m ² abs. to 2 MN/m ² (290lbf/in ²) abs.	25kN/m ² abs. to 7MN/m ² (1,015lbf/in ²) abs. ²	25kN/m ² abs. to 70MN/m ² (10,153lbf/in ²) abs.	25kN/m ² abs. to 170MN/m ² (24,656lbf/in ²) abs.	Special Test
Impact	No Test	50g (1.8oz) from 1m (3.28ft) and free drop ten times to a steel surface from 1.5m (4.92ft)	200g (7oz) from 1m	2kg (4.4lb) from 1m	5kg (11lb) from 1m	20kg (44lb) from 1m	Special Test
Vibration	No Test	30min 25 to 500Hz at 5g peak amp.	30min 25 to 50Hz at 5g peak amp. and 50 to 90Hz at 0.635mm amp. peak to peak and 90 to 500Hz at 10g	90min 25 to 80Hz at 1.5mm amp. peak to peak, and 80 to 2000Hz at 20g	Not Used	Not Used	Special Test
Puncture	No Test	1g (15.4gr) from 1m	10g (154gr) from 1m	50g (1.76oz) from 1m	300g (10.6oz) from 1m	1kg (2.2lb) from 1m (3.28ft)	Special Test

The tests are performed on two sources. Different specimens of the same source design are allowed for each test in the above table. To pass a test the sealed source must retain its activity after each test and pass the prescribed leak test. Source performance is generally described as C12345, a letter and five digits. The letter will be either C or E. C indicates the activity does not exceed limits established by radionuclide (dependent upon its toxicity and the solubility of its physical form). E indicates the activity exceeds those limits. The five digits indicate respectively, the highest test passed for temperature, pressure, impact, vibration and puncture.

SEALED SOURCE USAGE / TEST & CLASS		Temperature	Pressure	Impact	Vibration	Puncture
Radiography-Industrial	Unprotected Source	4	3	5	1	5
	Source in Device	4	3	3	1	3
Medical	Radiography	3	2	3	1	2
	Gamma Teletherapy	5	3	5	2	4
Gamma Gauges (medium & high energy)	Unprotected Source	4	3	3	3	3
	Source in Device	4	3	2	3	2
Beta gauges & source for Low Energy Gamma gauges or XRF analysis (excluding gas-filled sources)		3	3	2	2	2
Oil Well Logging (O.W.L.)		5	6	5	2	2
Portable moisture & density gauge (including hand-held or dolly transported)		4	3	3	3	3
General neutron source application (excluding reactor start-up)		4	3	3	2	3
Calibration Sources - activity greater than 30uCi		2	2	2	1	2
Gamma Irradiators	Categories, II, III, IV	5	3	4	2	4
	Category I	4	3	3	2	3
Ion Generators	Chromatography	3	2	2	1	1
	Static Eliminators	2	2	2	2	2
	Smoke Detectors	3	2	2	2	2

Technical Information

Nuclear Data

Radionuclide and Gamma Ray Data

Nuclide	Principle Decay Mode	Ref.*	Half-life	Particle Emission (E _{max})	Photon Emission (keV)	Branching Ratios (gammas per decay)
Na-22	EC	IAEA	950.8 ± 0.9 days	β ⁺ (545.5 keV)	511, 1274	1.78, 0.9994
Fe-55	EC	IAEA	999 ± 8 days	—	5.9-6.5 (Mn X-Rays)	0.283
Co-57	EC	IAEA	271.79 ± 0.09 days	—	122.1, 136.5	0.8560, 0.1068
Co-60	β ⁻	IAEA	1925.5 ± 0.5 days	β ⁻ (317.9 keV)	1173, 1332	0.9986, 0.9998
Ni-63	β ⁻	NCRP	96 ± 4 years	β ⁻ (65.88 keV)	—	—
Se-75	EC	IAEA	119.64 ± 0.24 days	—	136.0, 279.5	0.588, 0.250
Kr-85	β ⁻	NCRP	10.72 ± 0.01 years	β ⁻ (687 keV)	514.0	0.00434
Sr-90/ Y-90	β ⁻ β ⁻	NCRP	28.5 ± 0.2 years/ 2.667 days	β ⁻ (546.2 keV) β ⁻ (2283 keV)	—	—
Ru-106/ Rh-106	β ⁻ β ⁻	TRI	1.020 ± 0.003 years 29.80 seconds	β ⁻ (39 keV) β ⁻ (3540 keV)	— 511.9, 621.9	— 0.207, 0.098
Cd-109	EC	IAEA	462.6 ± 0.7 days	—	88.0	0.0363
Ba-133	EC	IAEA	3862 ± 15 days	—	81.0, 356.0	0.341, 0.619
Cs-137	β ⁻	IAEA	(1.102 ± 0.006) × 10 ⁴ days	β ⁻ (511.5 keV)	661.7	0.851
Pm-147	β ⁻	NCRP	2.6234 ± 0.0002 years	β ⁻ (224.7 keV)	—	—
Sm-151	β ⁻	TRI	90 ± 6 years	β ⁻ (421 keV)	—	—
Eu-152	EC (72.08%) β ⁻ (27.92%)	IAEA	4933 ± 11 days	β ⁻ (~600 keV)	121.8, 344.3, 1408	0.284, 0.266, 0.209
Gd-153	EC	NCRP	242 ± 1 days	—	97.4, 103.2	0.295, 0.211
Yb-169	EC	NCRP	32.03 ± 0.01 days	—	63.1, 198.0	0.437, 0.349
U-232	α	TRI	68.9 ± 1.0 years	α (5263 keV, 31.2%) α (5320 keV, 68.6%)	—	—
Am-241	α	IAEA	432.17 ± 0.66 years	α (5443 keV, 12.8%) α (5486 keV, 85.2%)	59.5	0.360
Cf-252	α (96.9%) SF (3.1%)	TRI	2.645 ± 0.008 years	α (6076 keV, 15.2%) α (6118 keV, 81.6%) 4292 n/s/μCi	—	—

* References:

- α: Alpha decay
 β⁻: Beta minus decay
 EC: Electron capture/Position decay
 IAEA: IAEA-TECDOC-619, 1991
 n/s: Neutrons/Second (as a result of spontaneous fission)
 NCRP: NCRP Report No. 58, 1985
 SF: Spontaneous fission decay
 TRI: "Table of Radioactive Isotopes", edited by Virginia Shirley, 1986



Inquiry Form

Form and Instructions

Instructions

- 1) Please make a photocopy of this form.
- 2) Fill out form completely, send it to us. One of our Source Design Specialists will then contact you.



metorX BV
Oostdijkseweg 12
3252LN Goedereede
www.meteorx.com
info@meteorx.com
+ 31(0) 187 630176

Industrial Sources Inquiry Form

Please include the following information with your submitted Source Design Request Form:

Name	
Title	
Company Name	
Address	
City	
State	
Zip/Postal Code	
Phone	
Fax	
Email Address	

Source Design Request Form

When completing the form, please provide as much information as possible.

Radionuclide	
Activity Content	
Activity Tolerance	
Calibration Required?	
Capsule (if known)	
Alternate Capsule Design (if known)	
Active Dimensions	
Capsule Dimensions	
Emission Type and Energy Required	
Application of Source	
Environment for Source Use (e.g. vacuum, high temp, corrosive)	
Quantity Required	
Other Information	



metorX BV
Oostdijkseweg 12
3252LN Goedereede
www.meteorx.com
info@meteorx.com
+ 31(0) 187 630176



Eckert & Ziegler
Isotope Products